

**A**Work in a chemical hood now onward **B****D**

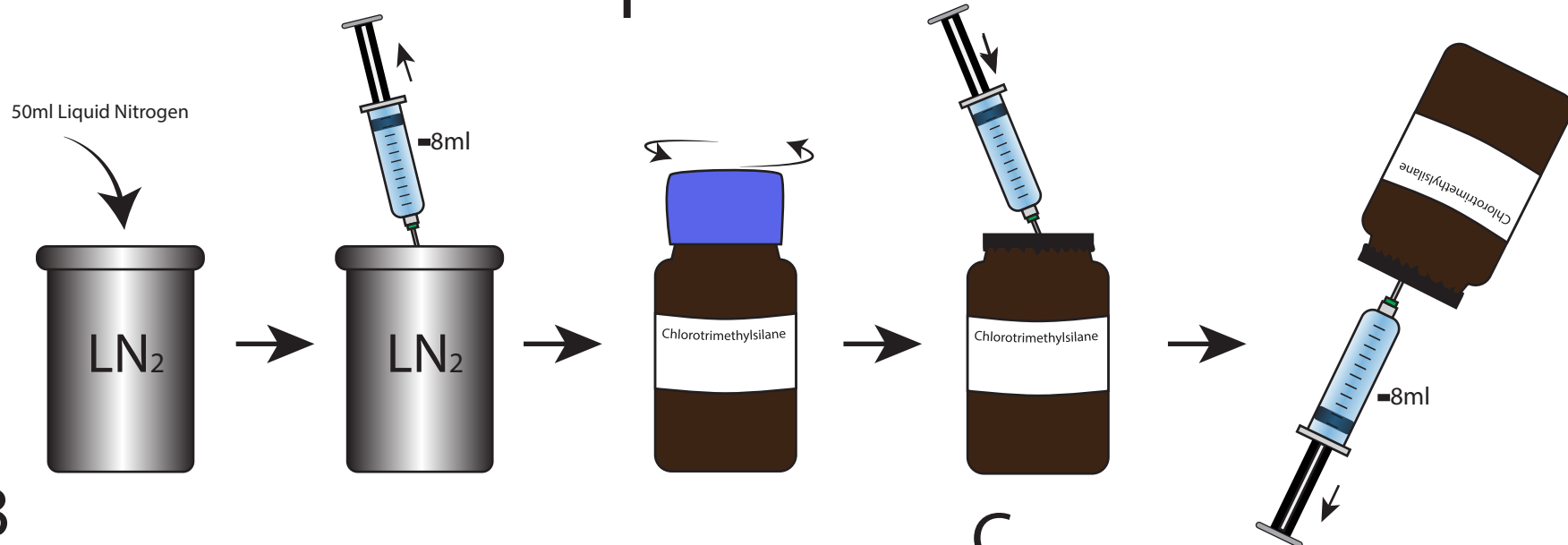

A

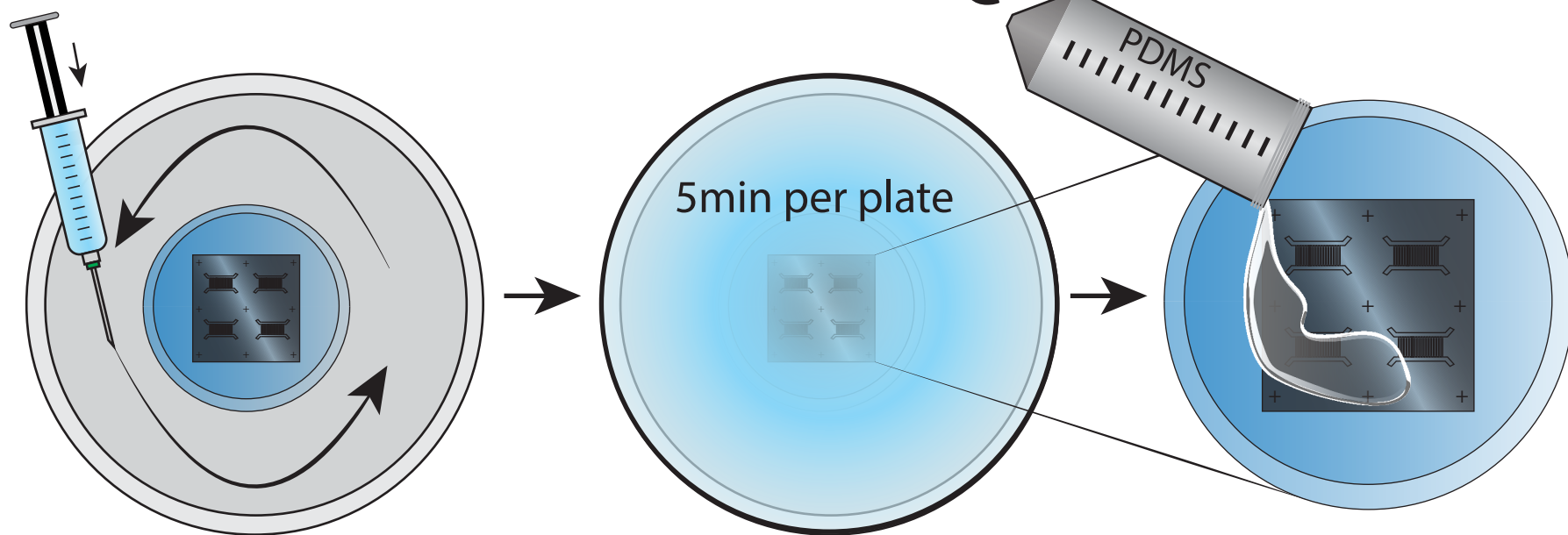
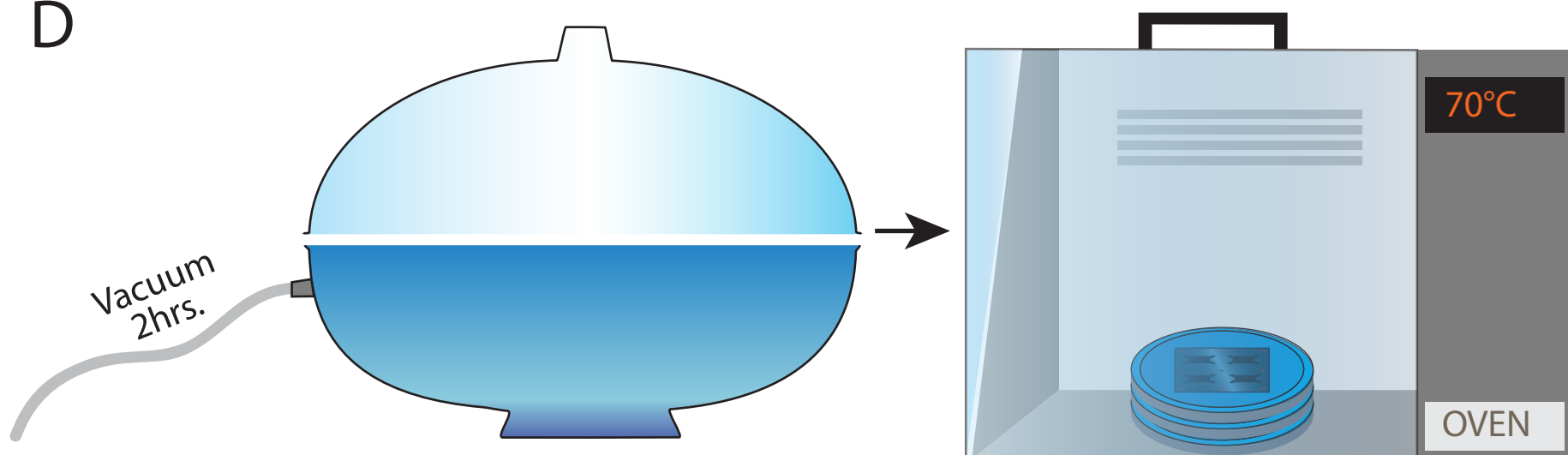
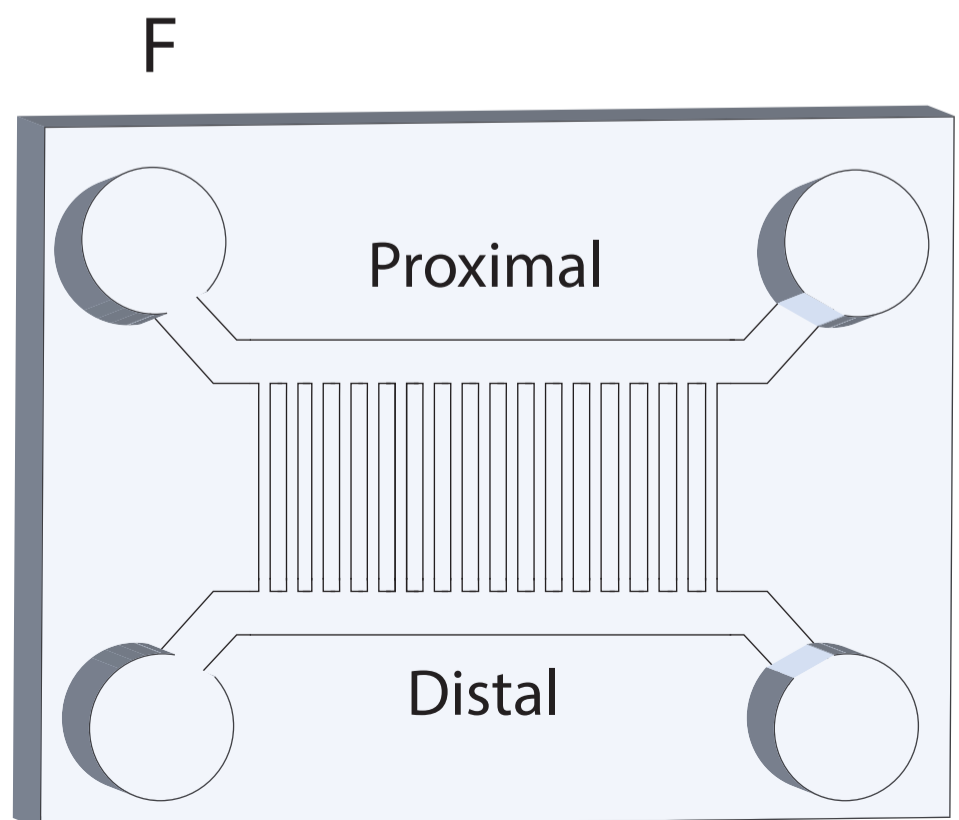
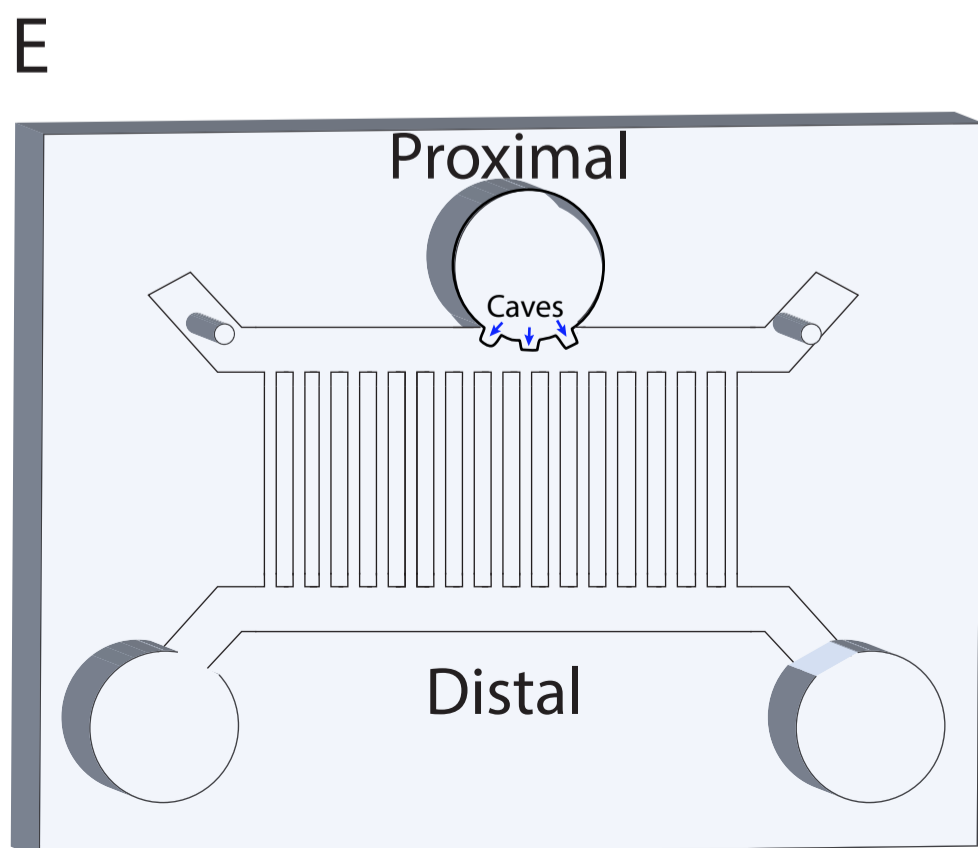
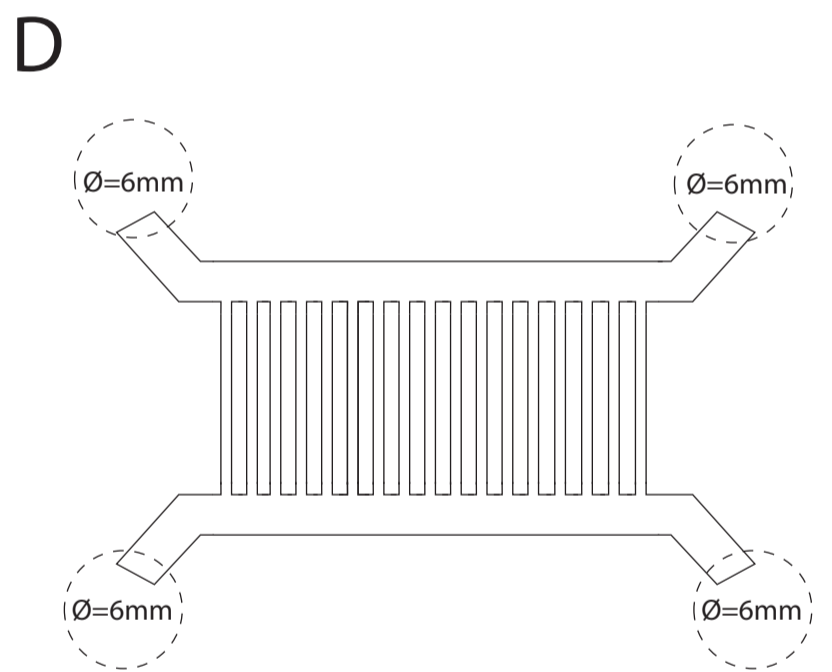
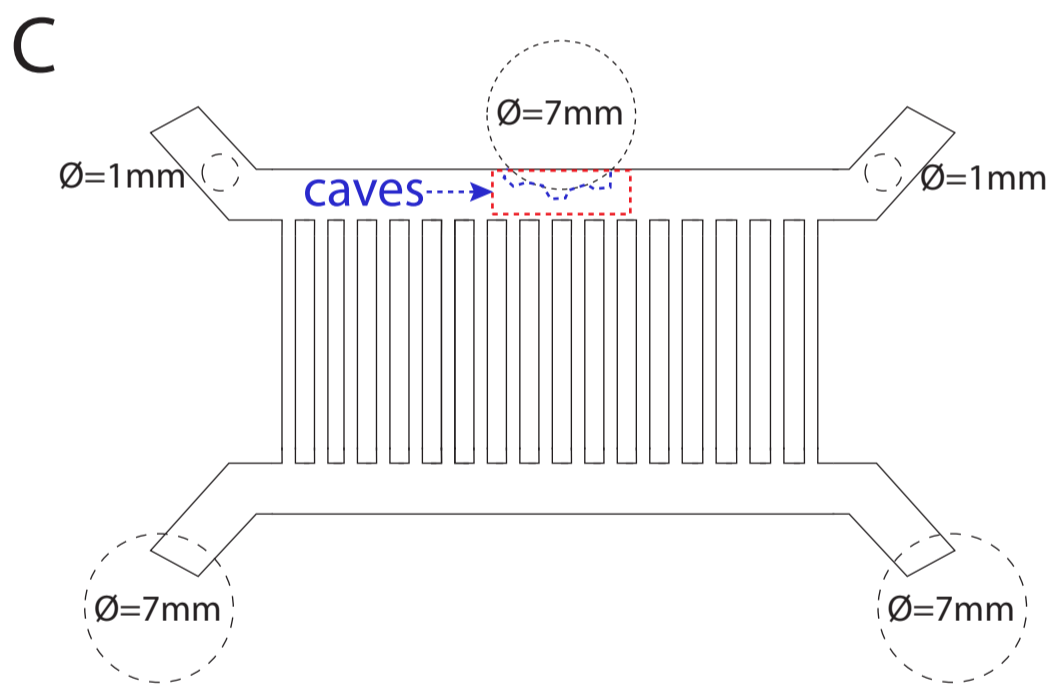
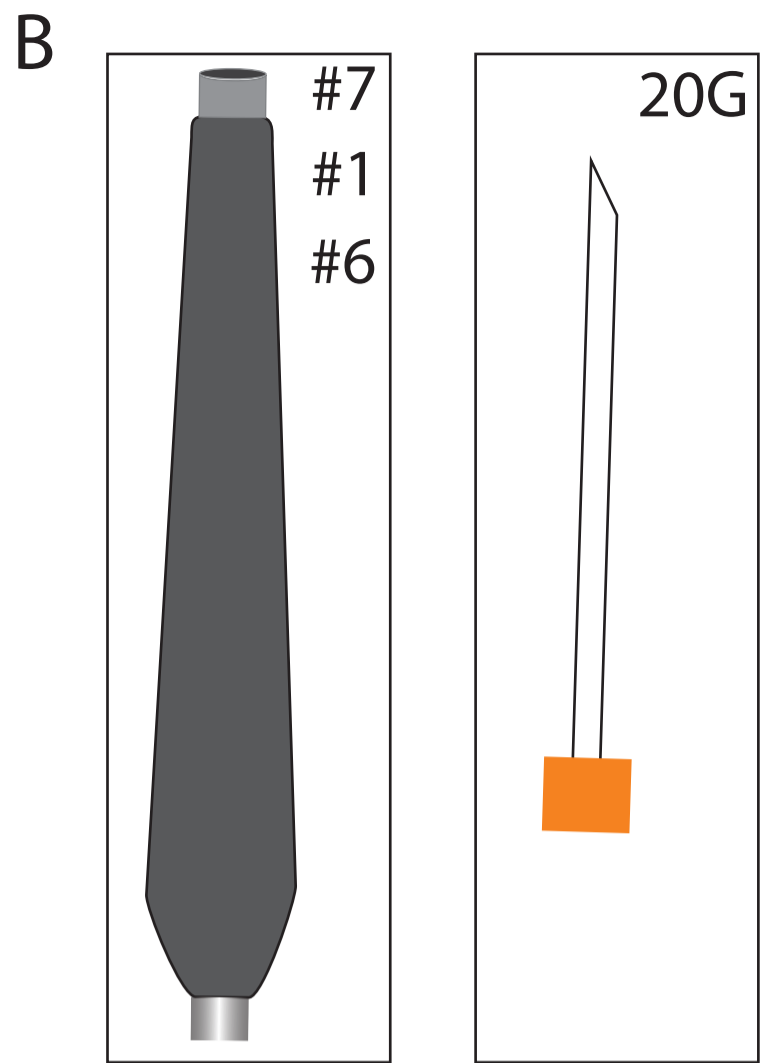
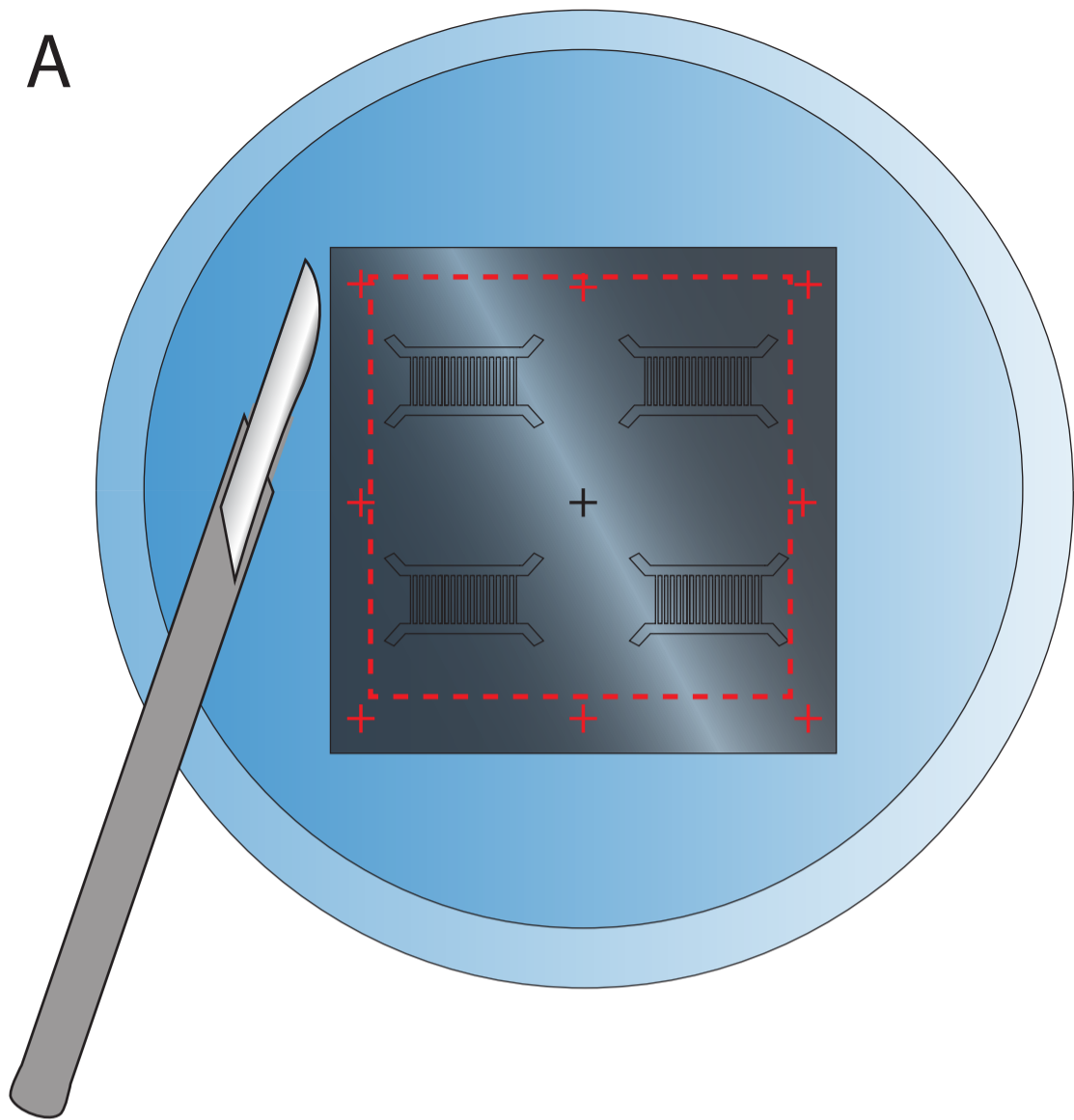
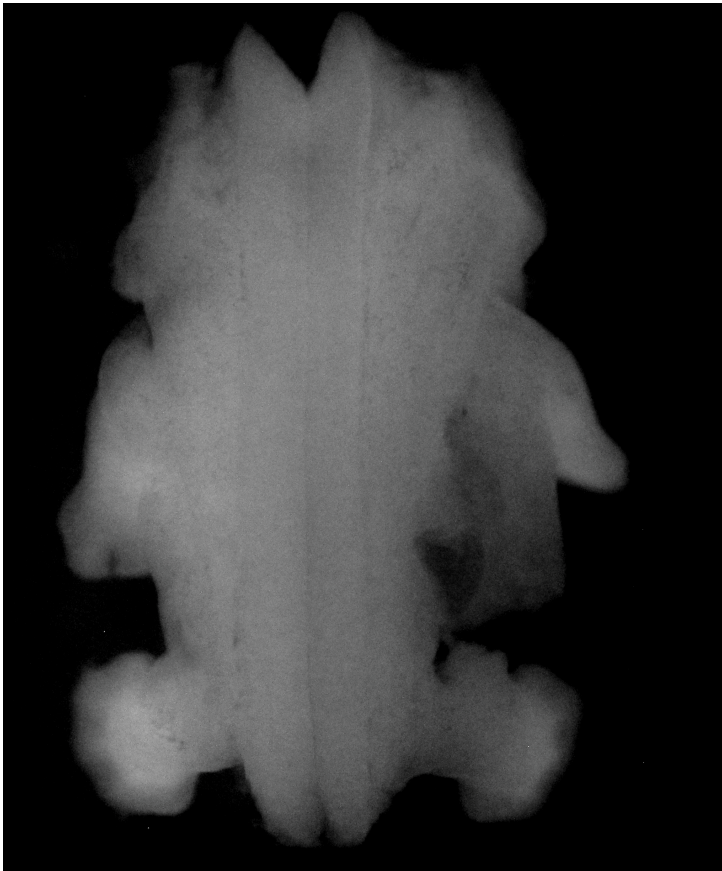

B



C



D

Mass Culture

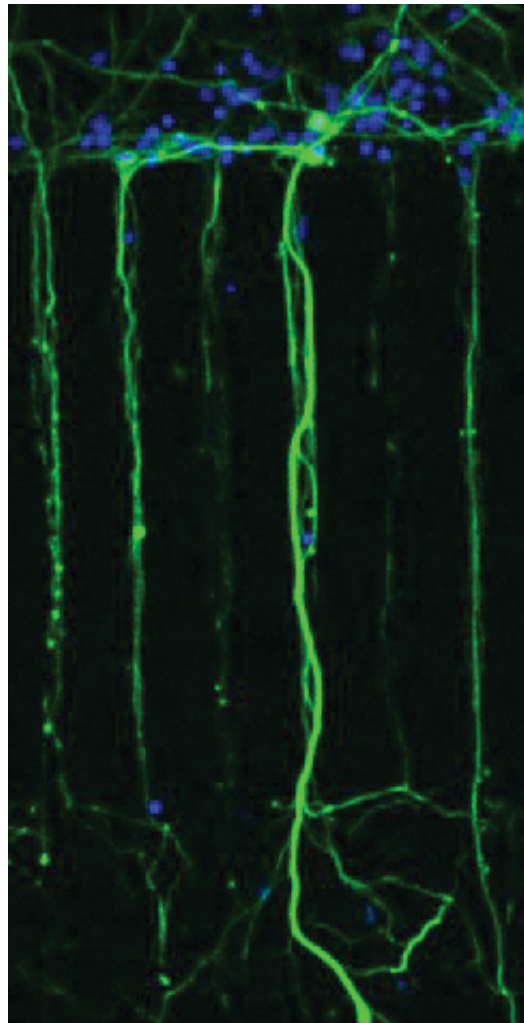

E

Explant Culture

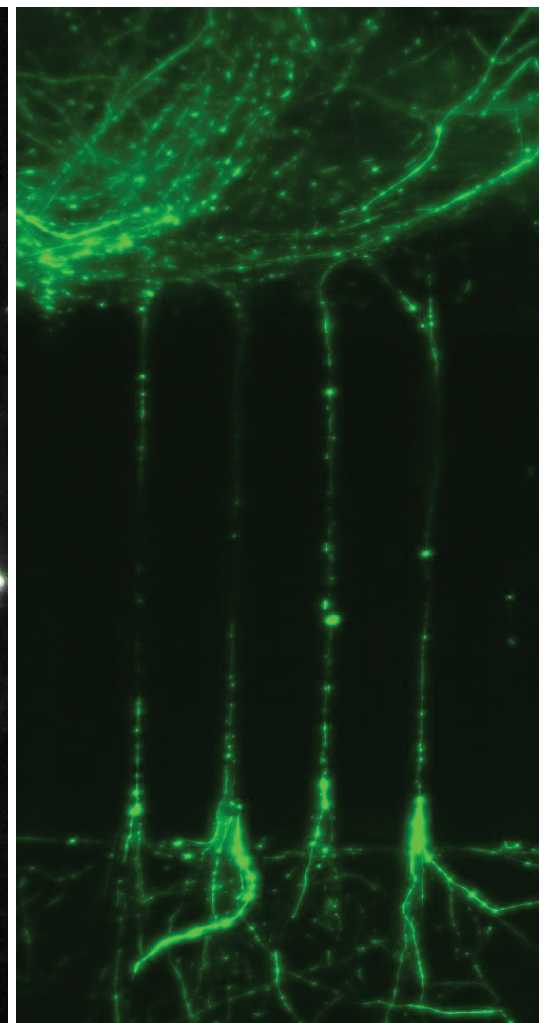
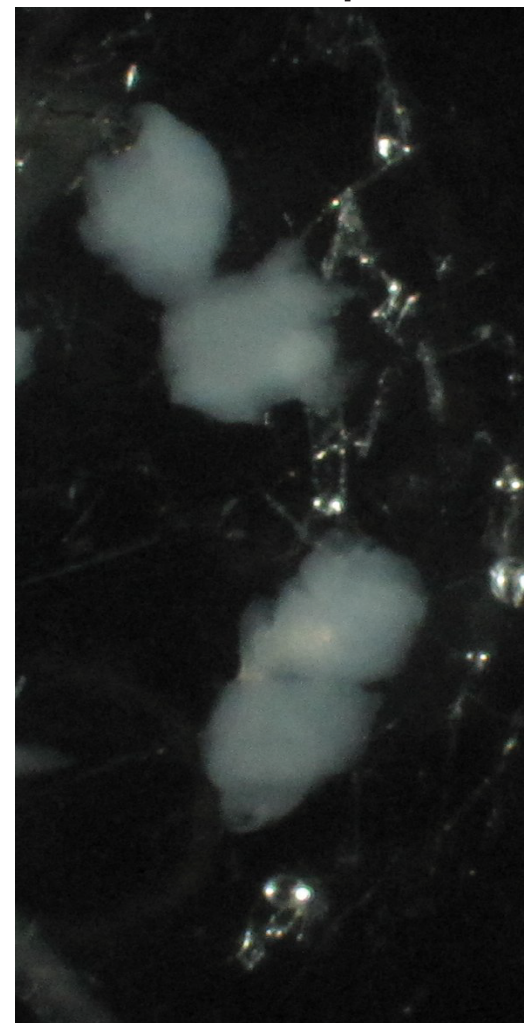

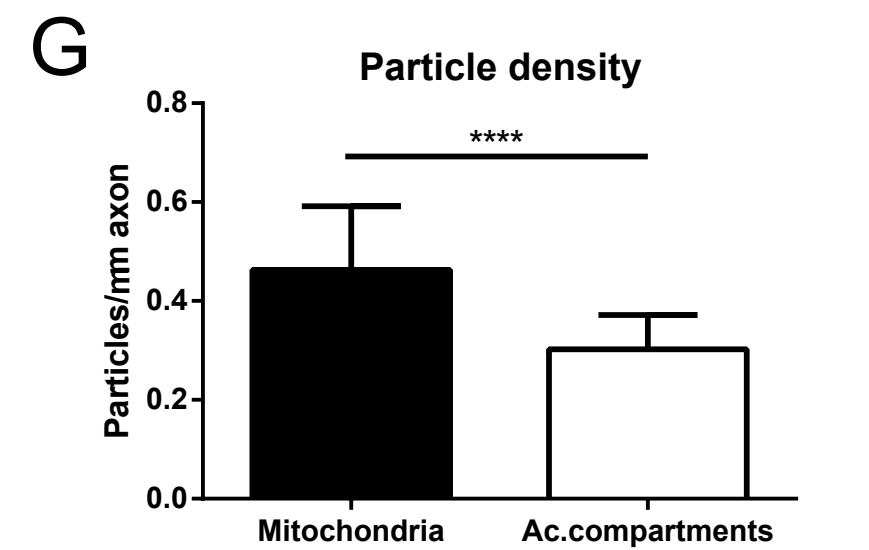
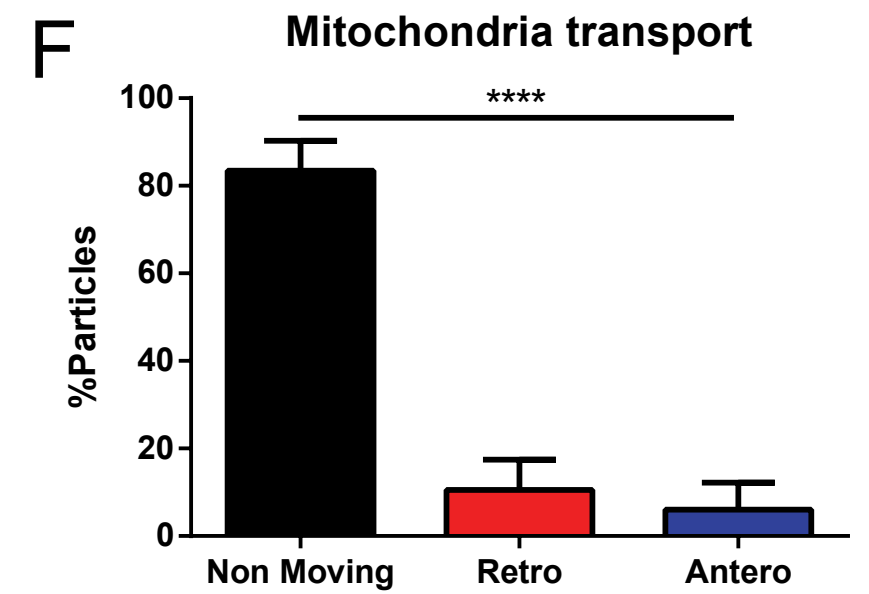
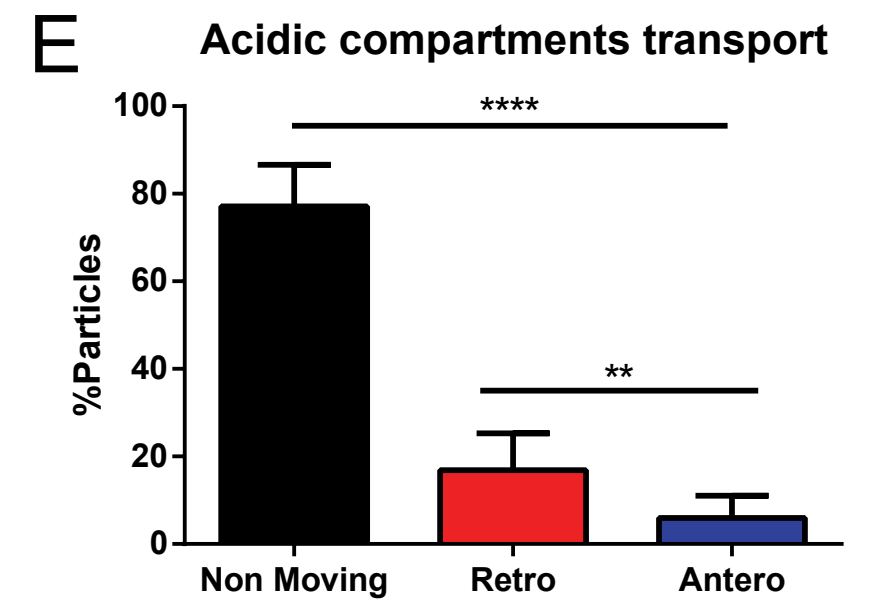
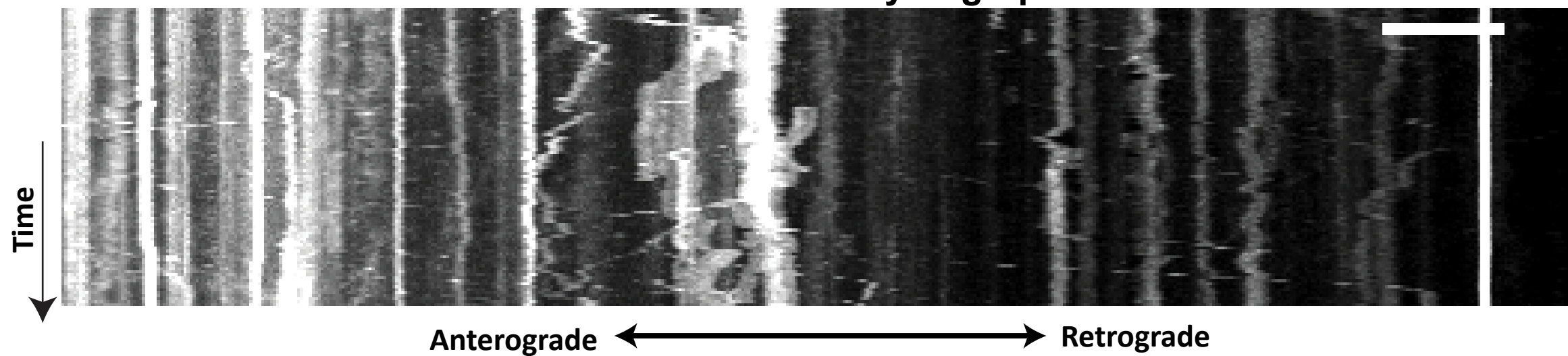
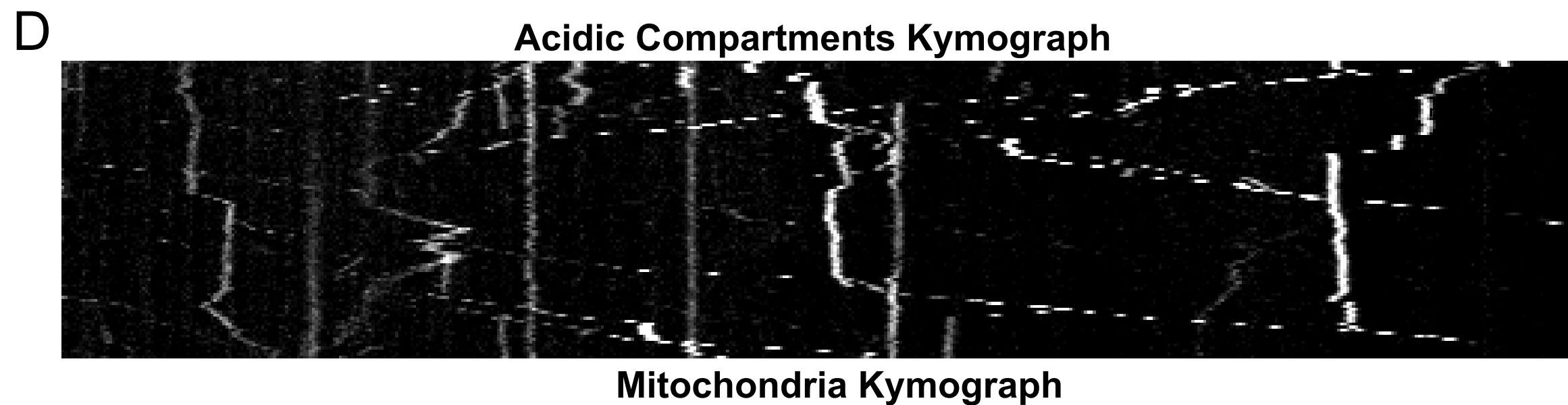
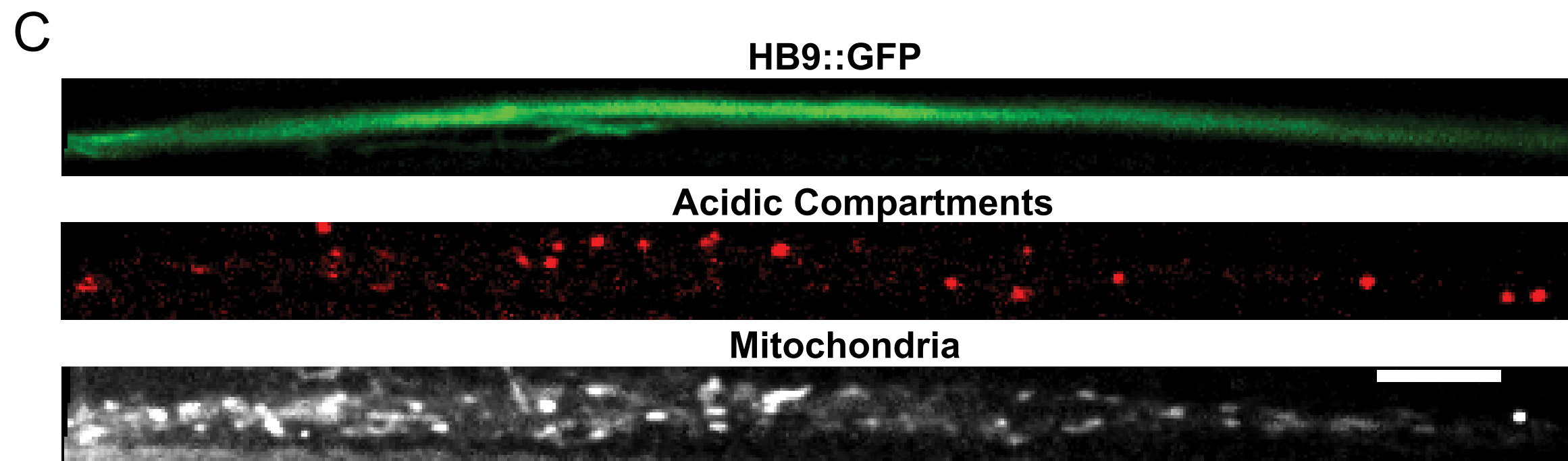
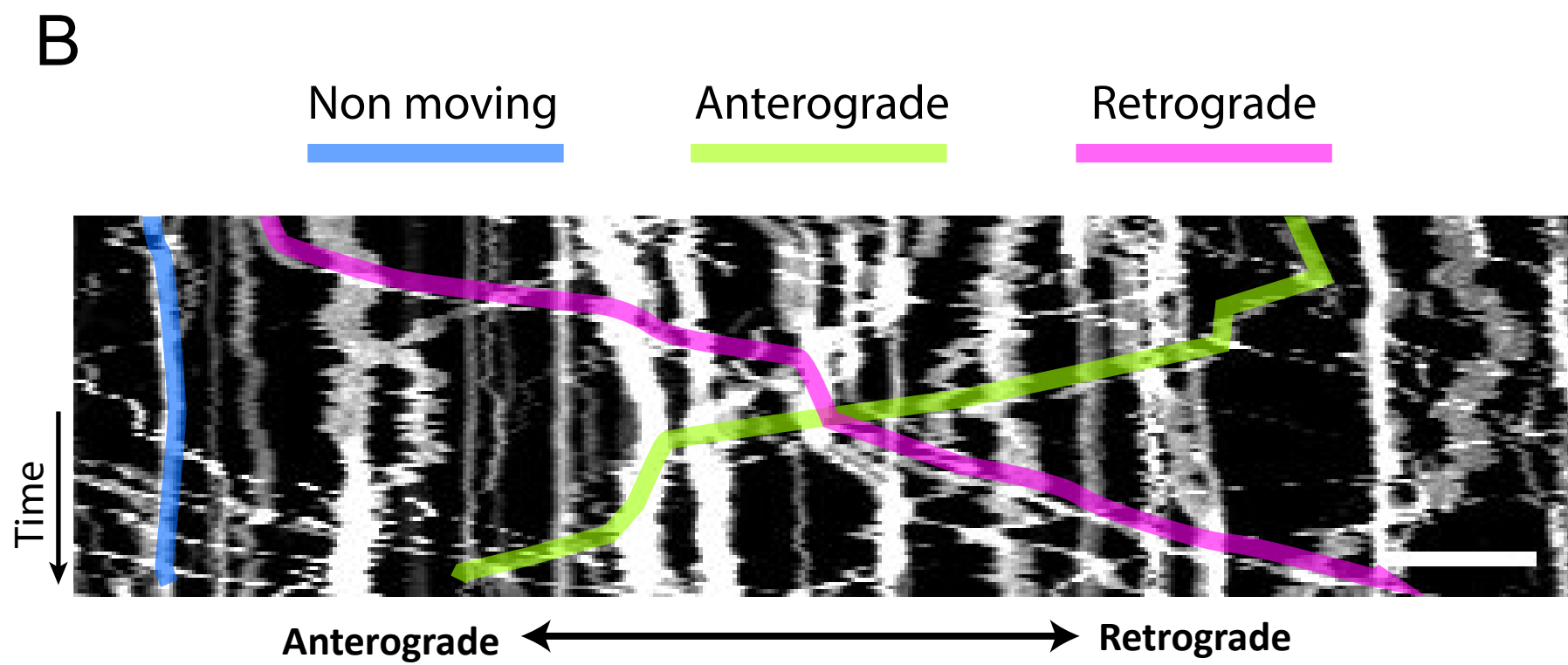
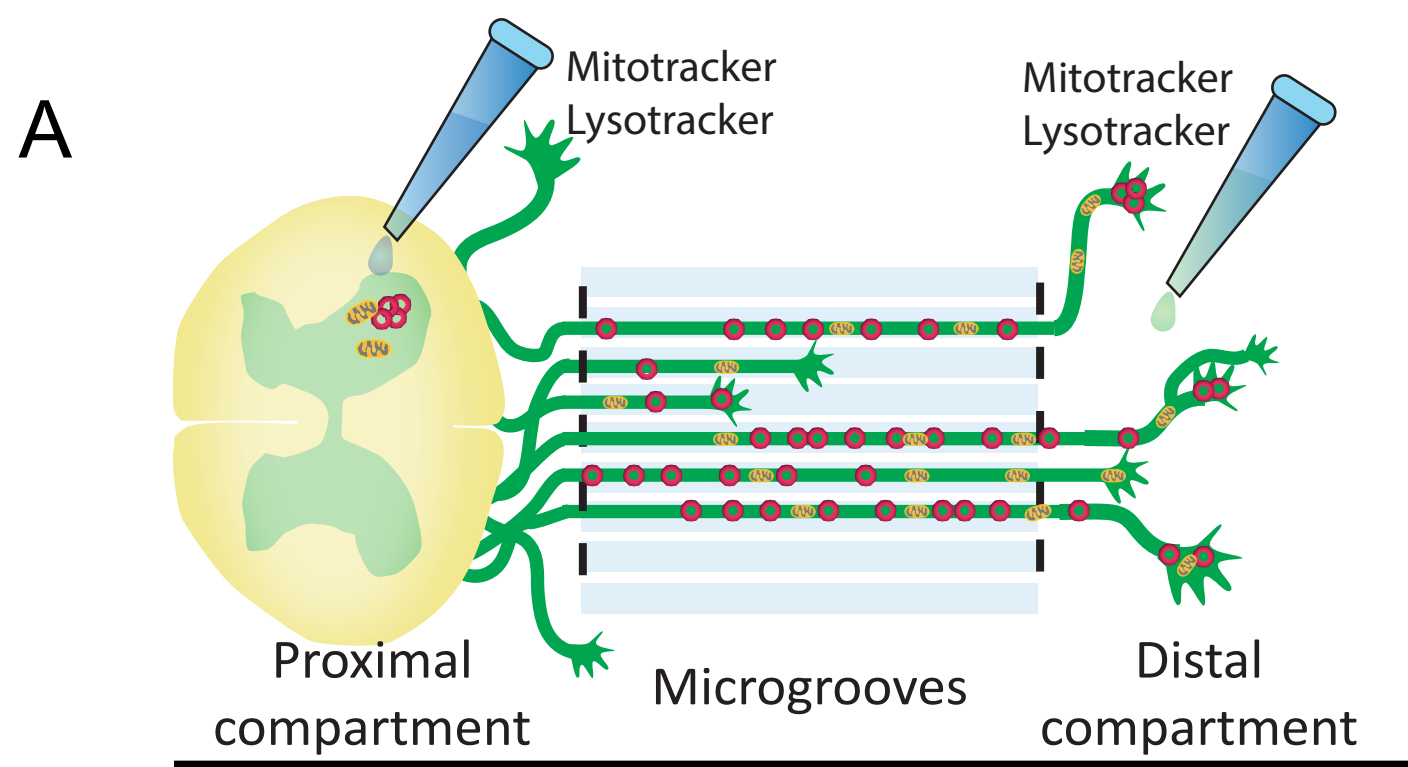

A

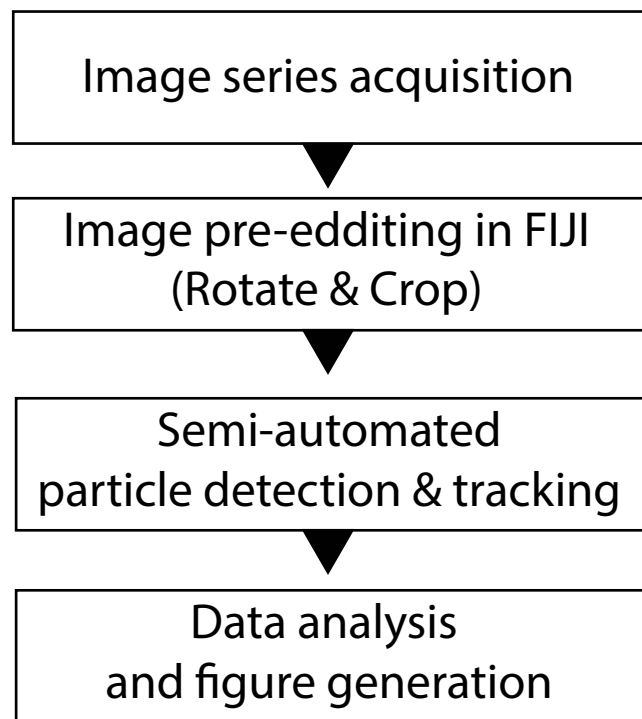

B

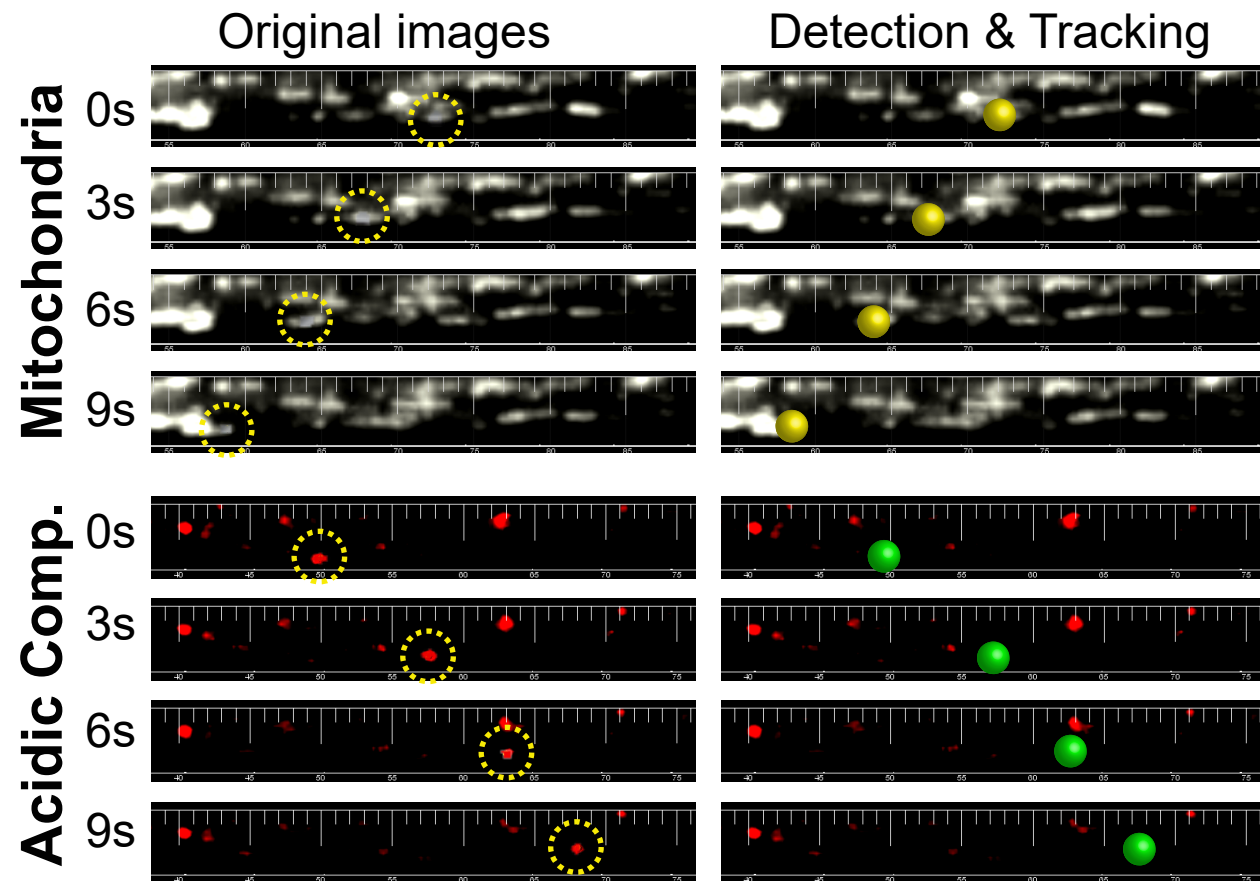

C

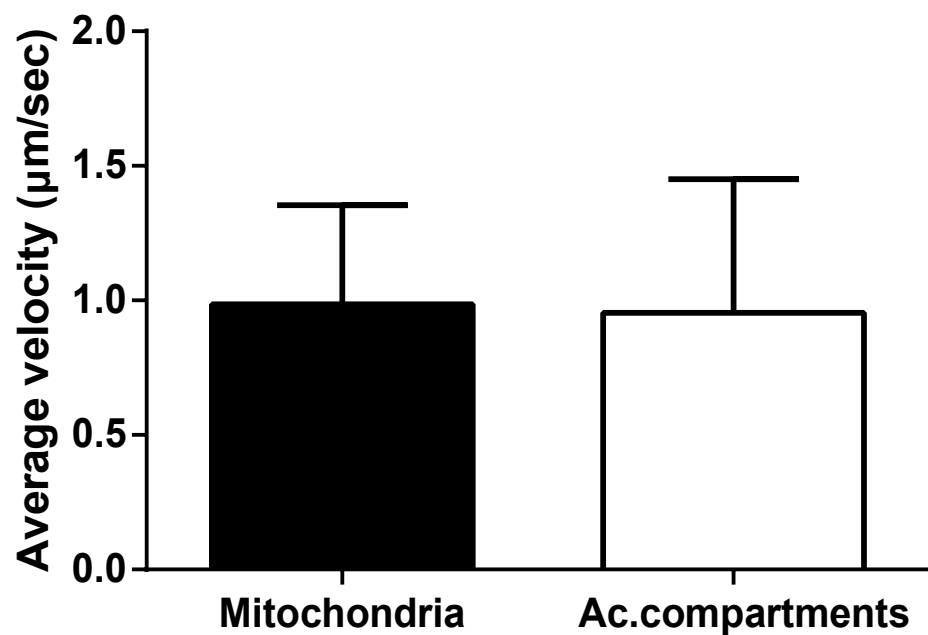

D

