

Journal of Visualized Experiments

Reduced-Gravity Environment Hardware Demonstrations of a Prototype Flow Cytometer and Companion Microfluidic Mixing Technology --Manuscript Draft--

Manuscript Number:	JoVE51743R4
Full Title:	Reduced-Gravity Environment Hardware Demonstrations of a Prototype Flow Cytometer and Companion Microfluidic Mixing Technology
Article Type:	Invited Methods Article - JoVE Produced Video
Keywords:	Point-of-care; prototype; Diagnostics; spaceflight; reduced gravity; parabolic flight; flow cytometry; fluorescence; cell counting; micromixing; spiral-vortex; blood mixing
Manuscript Classifications:	5.1.370: Diagnostic Techniques and Procedures; 5.5.200.500.363.342: Flow Cytometry; 5.7.553: Microbubbles; 93.33: Electronics and Electrical Engineering; 93.34.41: hydrodynamics; 93.34.53: mixing of liquids; 93.37: Mechanical Engineering; 95.52.10: biomedical instruments (aerospace medicine); 95.52.68: weightlessness effects (physiological, human); 95.52.9: bioengineering (aerospace medicine)
Corresponding Author:	William S. Phipps DNA Medicine Institute Cambridge, MA UNITED STATES
Corresponding Author Secondary Information:	
Corresponding Author E-Mail:	wphipps@dnamedinstitute.com
Corresponding Author's Institution:	DNA Medicine Institute
Corresponding Author's Secondary Institution:	
First Author:	William S. Phipps
First Author Secondary Information:	
Other Authors:	Zhizhong Yin Candice Bae Julia Z. Sharpe Andrew M. Bishara Emily S. Nelson Aaron S. Weaver Daniel Brown Terri L. McKay DeVon Griffin Eugene Y. Chan
Order of Authors Secondary Information:	
Abstract:	Until recently, astronaut blood samples were collected in-flight, transported to earth on the Space Shuttle, and analyzed in terrestrial laboratories. If humans are to travel beyond low Earth orbit, a transition towards space-ready, point-of-care testing is required. Such testing needs to be comprehensive, easy to perform in a reduced-gravity environment, and unaffected by the stresses of launch and spaceflight.

	<p>Countless POC devices have been developed to mimic laboratory scale counterparts, but most have narrow applications and few have demonstrable use in an in-flight, reduced-gravity environment. In fact, demonstrations of biomedical diagnostics in reduced gravity are limited altogether, making component choice and certain logistical challenges difficult to approach when seeking to test new technology. To help fill the void, we are presenting a modular method for the construction and operation of a prototype blood diagnostic device and its associated parabolic flight test rig that meet the standards for flight-testing onboard a parabolic flight, reduced-gravity aircraft. The method first focuses on rig assembly for in-flight, reduced-gravity testing of a flow cytometer and a companion microfluidic mixing chip. Components are adaptable to other designs and some custom components, such as a microvolume sample loader and the micromixer may be of particular interest. The method then shifts focus to flight preparation, by offering guidelines and suggestions to prepare for a successful flight test with regard to user training, development of a standard operating procedure (SOP), and other issues. Finally, in-flight experimental procedures specific to our demonstrations are described.</p>
<p>Author Comments:</p>	<p>[Blue stamps] in the manuscript refer to video files uploaded to a shared Dropbox folder (with corresponding names) that we would like included in the video production. Please contact me at wphipp@dnamedinstitute.com for access.</p> <p>Highlights in the protocol try to emphasize items that we think are plausible for the video. Please note the test rig is from 2010, and some of its parts and demonstrations may be unavailable. Some parts have been returned to NASA (e.g., the equipment rack)</p> <p>We do have additional in-flight footage that may be usable depending on the needs of the production team.</p> <p>Thank you.</p>
<p>Additional Information:</p>	
<p>Question</p>	<p>Response</p>
<p>If this article needs to be "in-press" by a certain date to satisfy grant requirements, please indicate the date below and explain in your cover letter.</p>	
<p>If this article needs to be filmed by a certain date to due to author/equipment/lab availability, please indicate the date below and explain in your cover letter.</p>	

October 22, 2013

Journal of Visualized Experiments
One Alewife Center, Suite 200
Cambridge, MA 02140

Dear JoVE Editors,

We are seeking to publish "Prototype Point-of-Care Blood Diagnostic Assembly with a Flow Cytometry Design for In-Flight Reduced-Gravity Environment Demonstration" in the Journal of Visualized Experiments (JoVE). The work is ideal for publication in JoVE's unique multimedia format because the use of accompanying video will significantly enhance information expressed in the manuscript. We believe this paper will be an asset to other researchers trying to approach reduced-gravity blood diagnostic testing.

William S. Phipps designed the in-flight experimental workflows to operate described demonstrations in flight, performed all described demonstration setup procedures required directly on the described test rig, optimized standard operating procedures for demonstrations in-flight, fabricated microfluidic chips using PDMS method, helped operate in-flight experiments, and wrote the paper and supporting documents. Zhizhong Yin programmed control/acquisition software, implemented electronics, fabricated SU-8 molds for chip fabrication, and contributed to reports that provided a basis for writing this paper. Candice Bae performed all demonstration setup procedures performed away from the described test rig (sample preparation), managed all shipments and orders, provided ground support during demonstrations, and contributed to reports that provided a basis for writing this paper. Julia Z. Sharpe, Andrew M. Bishara, and Eugene Y. Chan performed all other necessary design and engineering. Eugene Y Chan also conceived the described prototype and desired demonstrations, contributed to electronics design and implementation, helped perform in-flight demonstrations, and contributed to reports providing a basis for this paper. Emily S. Nelson and Aaron Weaver participated in pre-flight prep, in-flight testing, and data review. Daniel Brown performed pre-flight system analysis to ensure flight-readiness. Terri L. McKay worked on aspects of the micromixing. DeVon Griffin assisted with programmatic aspects of the flight.

JoVE editor Nandita Singh has assisted us in the submission process. We recommend the following 6 peer reviewers based on their work performed in the reduced-gravity environment:

- (1) Paul Yager (U. of Washington, Dept. of Bioengineering, yagerp@uw.edu)
- (2) Robert J. Ferl (U. of Florida, Horticultural Sciences Department, robferl@ufl.edu)
- (3) Timothy J. Broderick (U. of Cincinnati, andrew.kirkpatrick@calgaryhealthregion.ca)
- (4) Oliver Ullrich (University Zurich, Institute of Anatomy, oliver.ullrich@anatom.uzh.ch)
- (5) Peter Norsk (NASA Human Research Program, peter.norsk@nasa.gov)
- (6) Jeffrey S. Taube (Dartmouth College, Psychological & Brain Sciences, jeffrey.taube@dartmouth.edu)

Thank you.

Sincerely,



Eugene Y. Chan, MD
President
DNA Medicine Institute
echan@dnamedinstitute.com

TITLE: Reduced-Gravity Environment Hardware Demonstrations of a Prototype Miniaturized Flow Cytometer and Companion Microfluidic Mixing Technology.

AUTHORS:

Phipps, William S. *
DNA Medicine Institute
Cambridge, MA, USA
wphipps@dnamedinstitute.com

Yin, Zhizhong *¹
DNA Medicine Institute
Cambridge, MA, USA
zzyin@jhu.edu

Bae, Candice
DNA Medicine Institute
Cambridge, MA, USA
cbae@dnamedinstitute.com

Sharpe, Julia Z. ²
DNA Medicine Institute
Cambridge, MA, USA
jjimm@alum.mit.edu

Bishara, Andrew M.
Harvard Medical School
Boston, MA, USA
andrew_bishara@hms.harvard.edu

Nelson, Emily S.
NASA Glenn Research Center
Cleveland, OH, USA
emily.s.nelson@nasa.gov

Weaver, Aaron S.
NASA Glenn Research Center
Cleveland, OH, USA
aaron.s.weaver@nasa.gov

Brown, Daniel
ZIN Technologies
Cleveland, OH, USA
daniel.brown@zin-tech.com

McKay, Terri L.
NASA Glenn Research Center
Cleveland, OH, USA
terri.l.mckay@nasa.gov

Griffin, DeVon
NASA Glenn Research Center
Cleveland, OH, USA
devon.w.griffin@nasa.gov

Chan, Eugene Y.
DNA Medicine Institute
Cambridge, MA, USA
echan@dnamedinstitute.com

*These authors contributed equally to this publication.

¹Current affiliation: Johns Hopkins University, Baltimore, MD, USA

²Current affiliation: GnuBIO, Cambridge, MA, USA

CORRESPONDING AUTHOR: Eugene Y. Chan (617-233-7656)

KEYWORDS: Point-of-care, prototype, diagnostics, spaceflight, reduced gravity, parabolic flight, flow cytometry, fluorescence, cell counting, micromixing, spiral-vortex, blood mixing

SHORT ABSTRACT: Spaceflight blood diagnostics need innovation. Few demonstrations have been published illustrating in-flight, reduced-gravity health diagnostic technology. Here we present a method for construction and operation of a parabolic flight test rig for a prototype point-of-care flow-cytometry design, with components and preparation strategies adaptable to other setups.

LONG ABSTRACT: Until recently, astronaut blood samples were collected in-flight, transported to earth on the Space Shuttle, and analyzed in terrestrial laboratories. If humans are to travel beyond low Earth orbit, a transition towards space-ready, point-of-care testing is required. Such testing needs to be comprehensive, easy to perform in a reduced-gravity environment, and unaffected by the stresses of launch and spaceflight. Countless POC devices have been developed to mimic laboratory scale counterparts, but most have narrow applications and few have demonstrable use in an in-flight, reduced-gravity environment. In fact, demonstrations of biomedical diagnostics in reduced gravity are limited altogether, making component choice and certain logistical challenges difficult to approach when seeking to test new technology. To help fill the void, we are presenting a modular method for the construction and operation of a prototype blood diagnostic device and its associated parabolic flight test rig that meet the standards for flight-testing onboard a parabolic flight, reduced-gravity aircraft. The method first focuses on rig assembly for in-flight, reduced-gravity testing of a flow cytometer and a companion microfluidic mixing chip. Components are adaptable to other designs and some

custom components, such as a microvolume sample loader and the micromixer may be of particular interest. The method then shifts focus to flight preparation, by offering guidelines and suggestions to prepare for a successful flight test with regard to user training, development of a standard operating procedure (SOP), and other issues. Finally, in-flight experimental procedures specific to our demonstrations are described.

INTRODUCTION: The inadequacy of current space-ready health diagnostics presents a limiting factor to deeper manned space exploration. Diagnostics need to be comprehensive, easy to use in reduced gravity, and relatively unaffected by the stresses of launch and spaceflight (e.g., high g-forces, vibration, radiation, temperature changes, and cabin pressure changes). Developments in point-of-care testing (POCT) may translate to effective spaceflight solutions through the use of smaller patient specimens (e.g., a finger prick), simpler and smaller fluidics (i.e., microfluidics), and reduced electrical power requirements, among other advantages. Flow cytometry is one attractive approach for in-space POC because of the broad utility of the technology, including toward cell counting and biomarker quantification, as well as significant miniaturization potential. Previous space-relevant flow cytometers include the ‘nuclear packing efficiency’ (NPE) instrument that utilized simultaneous arc-lamp induced fluorescence and electronic volume (Coulter volume) measurement¹⁻⁴, a relatively small benchtop flow cytometer representing the ‘first generation of real-time flow cytometry data during zero gravity’⁵, a ‘sheathless microflow cytometer’ capable of 4 and 5-part white blood cell (WBC) differential count using pretreated 5 μ L whole blood samples⁶⁻⁹, and a ‘fiber-optic-based’ flow cytometer recently tested onboard in the International Space Station¹⁰.

Evaluating diagnostic technology for potential space applications is typically performed onboard reduced-gravity aircraft that use an approximately parabolic flight trajectory to simulate a chosen level of weightlessness (e.g., zero-gravity, martian-gravity)¹¹. Evaluation is challenging because flight opportunities are limited, repetitive short windows of microgravity can make it difficult to assess methodologies or processes that normally require uninterrupted periods longer than 20-40 seconds, and demonstrations may require additional equipment not easily utilized in-flight¹²⁻¹⁵. Furthermore, previous demonstrations of *in vitro* diagnostic (IVD) technologies used in, or designed for, reduced gravity are limited and much work remains unpublished. In addition to the above flow cytometers, other space-relevant IVD-technologies described in the literature include a whole blood staining device for immunophenotyping applications¹⁶, an automated camera-based cytometer¹², a handheld clinical analyzer for integrated potentiometry, amperometry, and conductometry^{12,17}, a microfluidic ‘T-sensor’ device for analyte quantitation that relies on diffusion-based mixing and separation¹⁸, and a rotating ‘lab on a CD’ diagnostics platform^{19,20}. Newcomers to reduced gravity testing may also look to parabolic flight demonstrations unrelated to *in vitro* diagnostics when attempting to make device evaluation possible (or figuring out what *is* possible). Demonstrations from other previous medical or biological experimentation with well-documented flight preparation, in-flight strategies, and flight test equipment are included in **Table 1**^{15, 21-35}. These may be informative due to inclusion of manual in-flight tasks, use of specialized equipment, and experimental containment.

[Place Table 1 here]

To expand on previous examples and provide greater insight into successful in-flight demonstrations, we are presenting a modular and adaptable procedure for construction and operation of a prototype flow cytometer with related microfluidic mixing technology as part of a parabolic flight test rig. The rig enables demonstrations of sample loading, microfluidic mixing, and fluorescent particle detection, and was tested onboard the 2010 NASA Facilitated Access to the Space Environment (FAST) parabolic flights, flown from September 29 to October 1 2010. These demonstrations pull from the beginning, middle, and end, respectively of a potential device workflow in which fingerstick-sized blood samples are loaded, diluted or mixed with reagents, and analyzed via optical detection. Scaling a flow cytometer into a compact unit requires innovation and careful part selection. Custom and off-the-shelf components are used here, chosen as best early approximations of final component choices, and may be adaptable to the designs of other innovators. Following an outline of prototype component choices, setup is described on a support structure serving as a skeleton for rig assembly. Prototype components are assigned locations, secured, and accompanied by additional components necessary for successful experimentation. Attention then shifts to more abstract procedures involving standard operating procedure (SOP) development, training, and other logistics. Finally, demonstration-specific procedures are described. The strategies described here and the choices of supporting rig components (e.g., microscope, acrylic box, etc.), although implemented here for specific prototype, speak to the general issues and challenges relevant to testing any blood diagnostic equipment in a reduced-gravity environment.

In the 2010 flights, two lunar-gravity (achieving approximately 1/6 earth gravity) and two micro-gravity flights were scheduled across 4 days, although ultimately these were rescheduled across 3 days. Demonstrations were performed onboard a modified privately operated, narrow-body jet airliner ³⁶. Each flight provided 30-40 parabolas, each yielding about 20 seconds of high-gravitation (roughly 1.8 g) followed by 20-25 seconds of reduced-gravity conditions. After half of the parabolas were executed, the plane paused for a period of about 5-10 minutes in level flight to enable the plane to turn around and head back toward the landing site while performing the remainder of the parabolas.

PROTOCOL:

The human blood samples used in this protocol were collected with IRB approval using minimally invasive protocols (see Acknowledgements).

1. Rig Assembly

1.1) Assemble prototype components (fluidics, optical, electronic system control/ data acquisition) for a simple flow cytometry system to be used in reduced gravity conditions.

1.1.1) Prepare a pressure system with minimal weight and power needs to drive system fluidics

1.1.1.1) Connect a miniaturized air pump to a differential pressure sensor.

1.1.1.2) To maintain a constant driving pressure, control pump output using pulse-width-modulation and a duty cycle regulated using a proportional–integral–derivative controller in custom control software (step 1.1.7).

1.1.2) Assemble a fluid source container that can be loaded without trapping air (See Step 3.4)

1.1.2.1) Fit a rigid plastic vial (**Figure 1A**) with a latex diaphragm, firmly secured cap, and inlet air tubing at the vial base (sealed connection using optical adhesive).

1.1.2.2) Ensure that the pump pressurizes the vial without air or fluid leaks, compressing the diaphragm to drive fluid flow out of the cap exit tubing.

1.1.3) Design a fluid waste container to collect waste without building a backpressure that will compromise flow

1.1.3.1) Use a vial-glued-within-a-vial design (**Figure 1B**) for double containment.

1.1.3.2) Cap the vials with a secured foam sponge window that traps floating waste but allows air pressure equalization with the cabin environment.

1.1.4) Make a sample loader for use in reduced gravity

1.1.4.1) Machine and assemble a spring-loaded clamp design with guiderails (**Figure 1C**) such that it reliably clamps a sheath-fitted capillary between two O-rings in the fluid line. Ensure it preserves sample volume when loading, accommodates system priming when a sample is not inserted, and avoids errant bubble introduction.

1.1.4.2) Ensure that in the absence of a capillary, the springs press the O-rings together to complete the fluid line and enable priming without leaking (**Fig. 1D**, left).

1.1.5) Design a micromixer that does not rely on powered mechanical subcomponents to function

1.1.5.1) Conceive a two-inlet spiral-vortex micromixer (**Figure 1E**) that achieves chaotic advection necessary to overcome laminar flow within the microfluidic channels. This design delivers all entering fluid downstream so that one sample run does not affect the next.

1.1.5.2) For convenience, fabricate chosen design using the rapid-prototype polydimethylsiloxane (PDMS) method (**Figure 1F**). Utilize a two-dimensional computer-aided

designed photomask printed at 20,000 dpi to fabricate the necessary SU-8 mold in a cleanroom facility³⁷.

Use a modified 23 gauge fit to a vertical drilling mill to drill holes at the inlets, vortex, detection inlet, and detection outlet spots, and a hand magnifier to help aim the needle. Cut out the chips from the PDMS using a razorblade and fit the holes with 0.5" hollow steel pins sticking out of the non-molded back side of the chip. Connect the central spiral exit pin to the detection channel entrance pin using microbore tubing.

1.1.5.3) Thoroughly clean chip with ethanol and dry molded surface with matte scotch tape. Use an empty syringe to blow ethanol out of the pins. Treat PDMS chip and a pristine cover glass inside plasma cleaner and bond them within 10 seconds by applying light pressure, checking immediately by light microscopy that the chip is fully pressed without compromising channel patency.

1.1.6) Mount a palm-sized miniature optical block to detect individual flowing particles.

1.1.6.1) The design in **Figure 2AB** is suitable for two-color epifluorescence laser illumination and detection, and utilizes a PDMS straight-channel (120 by 200 um) flow cell for convenience.

1.1.6.2) Mount block (**Fig. 2C**) using commercially available optomechanical components and align fiber-coupled single photon counting modules.

1.1.7) Design electronics and software for device control and data acquisition

1.1.7.1) For convenience in early prototyping, utilize hand-soldered pieces connected to data acquisition (DAQ) cards (**Figure 2D**).

1.1.7.2) Code and program a custom software (example in Fig. 2E) to operate rig devices and synchronize all data.

1.2) Additional Components (not formally part of prototype).

1.2.1) Incorporate a 3 dimensional accelerometer (**Fig. 2D**, left) and a flow rate meter (not pictured). An accelerometer is present onboard the aircraft but (likely) cannot be directly synced to other recorded data.

1.3) Electrical power scheme

1.3.1) A mechanism for quick and complete electronics shutdown (required for safety reasons on reduced-gravity flights)

1.3.1.1) Connect a single power strip (with single I/O button) to the aircraft power distribution panel (120 VAC 60 Hz).

1.3.1.2) Remove laptop battery and set laptop to operate through power cable alone.

1.3.2) Power for all devices

1.3.2.1) Directly power the laptop (battery removed), a light microscope, and two photon detectors using power strip.

1.3.2.2) Power remaining devices via USB DAQ cards connected to the laptop or using batteries.

1.4) Flight-ready rig layout

1.4.1) Considerations for successful in-flight performance

1.4.1.1) Total space available is limited to a smaller area than provided for a similar demonstration on the ground (**Figure 3A**). Consider total space available and how that space will be divided between experimental rig space (including for components beyond those formally part of the prototype) and user space surrounding the rig. Experimental rigs vary in terms of forward or aft positioning, but this largely does not affect available operational space (or in-flight physics).

1.4.1.2) Determine which components are more appropriately accessed at a standing, kneeling, or floor height, as well as considering which components will benefit most from the protection attained within a structure support structure.

1.4.2) Rig support structure

1.4.2.1) Obtain or construct a vertical equipment rack that meets considered layout needs, contains all components, enables different vertical levels for organization, withstands flight accelerations, and securely attaches to the intended aircraft cabin floor.

1.4.2.2) Assign components to levels within the equipment rack (**Figure 3B**): a top level to place the laptop, a mid-rack level to contain prototype subcomponents and a floor level to contain extra wipes, gloves, and a miscellaneous waste container.

1.4.2.3) Conceive additional structures within the rack to accommodate different desired levels. Implement support beams at 'mid'-height to hold a 2 ft. by 2 ft. microscope breadboard plate for screwing down rig components, and support beams approximately 2 feet higher to support a flight-approved laptop trough.

1.4.2.4) Within vertical levels, determine optimal component arrangement, taking into account accessibility limitations incurred due to the presence of other components as well as due to the potential position/orientation of the rig itself onboard a flight (e.g., 4th side of a square rig may be close to aircraft wall, leaving only 3 sides accessible).

NOTE: The leg straps to secure test operators are at a fixed distance from the rig and are not available on all sides.

1.4.2.5) Based on these determinations, divide the breadboard plate into 4 quadrants (**Figure 3C**), placing dedicated locations for electronics and optical block toward the aircraft wall, and the sample loader and microfluidic chip toward the cabin space.

1.5) Prototype securing, containment, and visualization setup

1.5.1) System electronics

1.5.1.1) Design, laser-cut, and assemble a custom acrylic box (**Figure 2D**) to contain the DAQ cards (strapped down) and hand-soldered boards (screwed to box wall).

1.5.1.2) Utilize a swinging door for easy access (secured in-flight with fabric hook-and-loop fastener) and exit holes for USB cables and wires.

1.5.2) Sample loader

1.5.2.1) Fabricate a custom acrylic 'glove' box (**Figure 4A**) with arm access holes to provide a cubic space in which to perform the loader demonstration (**Figure 4C**) without risking contamination of the flight cabin.

1.5.2.2) Feed tubing to and from the loader through small circular holes in the side of the box.

1.5.3) Micromixer

1.5.3.1) Adapt equipment used on the ground. Bolt a stereomicroscope (**Figure 4B**) to the breadboard plate and fit it with a custom acrylic chip holder, also bolted to the plate.

1.5.3.2) Fit a USB CCD camera to the microscope eyepiece and connect it to the laptop (**Fig. 4D**) to save video synchronized with other data (gravity, driving pressure, and flow rate).

1.5.4) Optical block

1.5.4.1) Fabricate a custom opaque acrylic box (**Figure. 4A**, right) to cover the block, shielding it from ambient light and controlling laser hazards.

1.5.4.2) Utilize an optical filter 'window' to safely check laser function.

1.5.5) Laptop

1.5.5.1) Bolt a flight-approved laptop tray to the support beams within the support structure.

1.5.5.2) Use hook-and-loop fastener to secure USB cables along rack architecture.

1.6) In-flight demonstration implementation

1.6.1) Simple interventions to proceed through demonstrations

1.6.1.1) Incorporate additional components that eliminate required manual tubing adjustments in-flight or other actions that require significant dexterity or could risk leaking fluids into the cabin environment.

1.6.1.1.1) Custom-machine and integrate a pressure manifold (**Figure 5A**) consisting of an aluminum cylinder drilled and tapped to fit a screw-on needle luer adaptor serving as a pressure inlet. Drill smaller holes around the circumference to fit O-rings and microbore tubing as outlets. Use to pressure multiple source vials simultaneously.

1.6.1.1.2) Assemble a panel of three-way solenoid valves (**Figures 5B**) controlled by tandem MOSFET switches (**Figure 5C**) wired to a DAQ card. Adapt microbore tubing to fit valve ports. Use to control fluid flow from the different vials.

1.6.1.2) Program software to proceed through demonstrations (**Figure 6**) using single-button interventions (e.g., single click on the laptop).

1.6.2) Backup Manual Control

1.6.2.1) Add slide clamps to rig to enable some manual control over the fluidics, perhaps if tubing unexpectedly needs to be disconnected and reconnected during flight.

1.6.2.2) Include sufficient cleanup wipes in the floor rack section in case of leaks in flight.

1.7) Flight disturbance readiness: Ready system for possible sudden jolting forces, vibration, or passenger collision in flight.

1.7.1) Alignment stabilization

1.7.1.1) Apply quick-drying epoxy to aligned components that are easily misadjusted, particularly optical components.

1.7.1.2) Apply industrial grade epoxy over the quick-dry epoxy as well as to secure other components as necessary, including the CCD camera attachment to the microscope eyepiece.

1.7.2) Physical disturbance testing

1.7.2.1) Shake rig support structure with all components in place.

1.7.2.2) Check individual component functionality after subjecting the rig to the disturbance, particularly aligned optical components.

1.7.3) Passenger risk management

1.7.3.1) Apply foam padding to areas (corners, edges) of the vertical equipment rack structure that could harm a flight passenger that accidentally knocks into the rig (**Figure 4C**).

1.7.3.2) Secure padding with black duct tape.

2. Demonstration Preparation and Logistics

2.1) In-flight and ground team role assignments

2.1.1) Assign rig operator(s) to perform both rig setup *and* all hands-on operations in-flight. Hands-on operators can best visualize when rig setup is complete.

2.1.2) Assign an SOP reader to read the SOP aloud during training and in-flight. The process of SOP reading during training may identify awkward or ill-timed staging.

2.1.3) Assign ground support to perform sample preparation and any other preparation tasks not directly involving the rig, minimizing time burdens on rig operators.

2.2) Initial standard operating procedure (SOP) development

2.2.1) Write all steps to incorporate pre-flight (day before and morning before), in-flight, and post-flight procedures utilizing only equipment and materials that will be available at flight location. A 5 to 10 minute block of level plane flight may be available for last minute setup procedures before parabolas begin or at the halfway point as the plane turns around.

2.2.2) Assign in-flight experimental procedures to dedicated numbers of parabolas, noting that the parabolas will likely be separated partway through to allow the plane to turn around and head back to the landing site, and that another group may request the plane to level out mid-experiment or fewer parabolas may be flown than expected.

2.2.3) Conceive demonstration procedures to minimize biological hazard risk beyond effective containment, avoiding actual biological specimens when possible. Utilize blue food dye spiked with fluorescent counting beads (**Fig. 1D**) as an alternative to blood during the sample loader demonstration.

2.3) Demonstration Training

2.3.1) Set a training schedule sufficient to fully revise and refine the SOP, as well as generate thorough ground control data to compare with flight data.

2.3.2) After performing pre-flight SOP, 'lock' the rig into a room to simulate the in-flight experience, cutting access to tools or ground materials. For even stricter training, mark off a section of the floor meeting the allocated dimensions that will be available in-flight³².

2.3.3) During training, follow SOP exactly, and use a stopwatch to announce 20 to 30 second parabolas, indicating entrance and exit of reduced gravity, as well as a mid-flight parabola break.

2.3.4) Incorporate finalized SOPs into actual flight day schedules, dividing 'pre-flight' activities between day-of-flight and day-before-flight

2.3.5) Train for unexpected in-flight occurrences including sudden forces hitting the rig or the plane suddenly leveling out in the middle of an experiment.

2.3.6) Test stabilities of samples and reagents when subjected to an extended break (hours or more) between pre-flight procedures and in-flight activity.. Note also that temperatures may be significantly higher at flight location

2.3.7) Train multiple individuals as primary operators to expertly operate the device in-flight. It is unpredictable who will get sick during the parabolas, and a given user may be unaffected on one flight and become sick on another.

2.4) Ground equipment and supporting materials.

2.4.1) Assemble a toolbox to include backup components and equipment necessary for repairs, including hand tools, soldering equipment, and glue/epoxy among many other items.

2.4.2) Gather sample and reagent quantities beyond what is intended for use during the scheduled flights in case unexpected flight postponement occurs after a sample or reagent has already been readied for flight.

2.5) Shipping

2.5.1) Setup shipment necessary to transport the rig, ground equipment (tools, centrifuge, pipets, vortex mixer, others) and perishables (blood cells, reagents). Ensure adequate time to receive, inspect, assemble, and test hardware for the flight campaign.

2.5.2) Encase rig on all sides except bottom using bubble wrap. Ship rig using a custom wooden crate box, fitted internally with foam pads and shock material.

2.5.3) Ship supporting ground equipment/tools in a rigid container or chest.

2.5.4) Ship perishables in 1 in thick insulated foam box, containing dry ice for items requiring -20 °C storage and freezer cool pack for items requiring 4 °C storage.

2.6) Pre-flight testing -- Perform pre-flight testing at the flight location to check functionality of all components several days before the flights.

Flight rigs are weighed and crane loaded onto the aircraft, and likely remain on the aircraft for the duration of the flight week.

3. In-flight Demonstrations

Demonstrations/experiments are divided between two day designations (“Day A” and “Day B” below). Day A is designated for the micromixing demonstration and Day B is designated for the particle detection and sample loading demonstrations.

3.1) Ground sample preparation for micromixer demonstrations (Day A only)

3.1.1) Dilute 3 mL blue food dye into 12 mL 1x phosphate buffered saline (PBS)

3.1.2) Dilute 3 mL yellow food dye into 12 mL 1x PBS.

3.1.3) Strain 15 mL of commercially purified red blood cells.

CAUTION: Because no testing methods can guarantee with 100% certainty the absence of an infectious agent, human derived products should always be handled as biological hazards.

3.1.4) Load sample vials (See Step 3.3) for each sample, plus an additional vial containing only saline.

3.2) Ground sample preparation for optical block demonstration

3.2.1) Combine 60 uL fluorescent counting beads with 14 mL 1xPBS (4.3 beads/ uL) with 1% Tween. Load into sample vial.

CAUTION: Handle all chemicals with caution and using personal protective equipment (PPE).

3.2.2) Dilute a 50 uL finger stick whole blood sample 100-fold with 1xPBS and add SYTO 83 dye for [Final] = 5 uM. Lightly vortex to mix. Incubate for >5 minutes at room temperature.

CAUTION: SYTO 83 dye is dissolved in dimethylsulfoxide (DMSO), which is readily absorbed through the skin. May be irritating to eyes, respiratory system and skin. Handle using PPE.

3.2.3) Centrifuge cell sample (at 2300 x g for 4 minutes), pipet off supernatant.

3.2.4) Wash stained cell sample by adding 1 mL 1xPBS, centrifuging at 2300 x g for 4 minutes pipetting off supernatant. Repeat two more times.

3.2.5) Return volume to 15mL with 1xPBS for to reach a final 1:500-fold dilution of original commercial stock. Strain cells and load into sample vial.

3.3) Ground sample preparation for sample loader demonstration (Day B only).

3.3.1) Prepare capillary consumables for sample loader demonstration by cutting micro-hematocrit capillary tubes into 15 mm segments with a razor blade.

3.3.2) Prepare sample for loader demonstration: Mix 250 uL stock fluorescent beads with 250 uL undiluted blue food dye (500 beads/ uL). Draw 250 uL sample into two 1 mL syringes, each fitted with a blunt tip needle that is taped shut with electrical tape.

3.4) Load fluid source vials

3.4.1) Apply fresh, powder-free latex diaphragm to vial (cut finger from glove acceptable). Make sure the diaphragm is long enough to extend from the vial floor and fold over the top outer rim. Slide the vial ring over the folded portion.

3.4.2) Place a temporary slide clamp onto cap outlet tubing that will prevent fluid expulsion during cap insertion.

3.4.3) Before filling the vial, negatively pressurize the vial with a syringe to expand the diaphragm. Pour fluid to top of vial and insert the cap at an angle such that no air is trapped under the cap during cap placement (some fluid will spill out). Briefly remove slide clamp to prime the outlet tubing and release collapsing pressure exerted by the diaphragm.

3.5) Prepare rig demonstrations

3.5.1) Connect and check all tubing connections

3.5.2) Hook source vials into system. Fit vials into a custom acrylic vial holder and secure them with and hook-and-loop fastener.

3.5.3) Empty any contained waste in vials or bins.

3.5.4) Check hard drive space and startup custom demonstration software.

3.5.5) Perform system fluidics priming procedure specific to each demonstration.

3.5.6) Swap in new batteries to any battery-powered device (e.g., accelerometer).

3.5.7) Manually shake fluorescent particle samples.

3.5.8) Run brief pre-flight test experiment.

3.6) Avoid in-flight motion sickness

3.6.1) Take provided medications (scopolamine and dextroamphetamine, both safe and effective for preventing motion sickness in-flight)

3.6.2) Heed recommended body positioning strategies in-flight (e.g., lie flat on back during increased gravity, with body straight and head cocked forward, and allow body to float up on its own during transition to reduced gravity). If possible, use several early parabolas to adjust to the gravity changes.

3.6.3) Retain a plastic vomit bag easily accessible in a front pocket. Vomiting can occur suddenly and without preceding nausea.

3.7) Position rig operators once in-flight, nearing dedicated parabola airspace. Provide enough space to allow rig operators to lie down during high-gravitation intervals and enable access to leg straps. Once parabolas begin, do not apply strong forces on body during reduced gravity as this may send the body up too quickly and somewhat dangerously .

3.8) Perform microfluidic mixer demonstration (Day A only)

3.8.1) Manually shake blood vial before test run.

3.8.2) Mix blood and saline in a 1:1 ratio at 1.5, 2, 3, 4, 5, and 6 psi, for at least 2 parabolas each, recording video data synchronized to other readings.

3.8.3) Inject air into saline inlet to test whether channel architecture will trap a bubble that could prevent optimal mixing.

3.8.4) Mix blue and yellow food dyes at 1.5, 2, 3, 4, 5, and 6 psi for at least 2 parabolas each, again recording synchronized data.

3.8.5) Apply slide clamps to system fluidics when finished to prevent further waste production.

3.8.6) Check data integrity before shutting down electronics in case demo repeat is required.

3.9) Perform optical block and sample loader demonstrations (Day B only)

3.9.1) Manually shake samples before running.

3.9.2) Drive fluorescent counting beads through the optical block for 3 parabolas. Flush system with saline for at least 1 parabola.

3.9.3) Repeat 3.8.1 for the fluorescently labeled WBCs.

3.9.4) Check data for any missing entities that need to be repeated before moving on to sample loader demonstration.

3.9.5) Begin recording sample loader demonstration using HD video recorder.

3.9.6) When the plane enters reduced gravity, use a sample syringe to place a drop of the counting bead dye mixture on a fingertip to simulate a finger prick sample. Use an unrealistically large drop (**Fig. 1B**) to test the limits of keeping a finger prick sample on a finger during reduced gravity.

3.9.7) Use capillary consumable to pick up sample (about 10 uL) off finger and load into capillary loader.

3.9.8) Wipe remaining sample off finger using wipes included in box.

3.9.9) Drive sample into optical system for detection.

3.9.10) Repeat tests several times using different operators.

3.9.11) Check data for any missing entities that need to be repeated before shutting down electronics.

3.10) Post-flight shutdown

3.10.1) Empty and dispose waste properly using biohazard labeled containment receptacles as necessary. Hazardous waste may require shipment out of the aircraft facility.

3.10.2) Thoroughly flush system, using a 5 mL syringe loaded with water to provide forceful cleaning. Flush valves backwards and forwards through all 3 ports.

3.10.3) Wipe down any mess using alcohol wipes.

3.10.4) Reprime system for next demonstration.

REPRESENTATIVE RESULTS: Representative results for the micromixer demonstration appear in **Figure 7**, as viewed by the CCD camera fitted to the stereomicroscope. Mixing can be visually assessed at any point along the spiral, as well as in the Exit channel for experiments involving two sets of fluids: blood/saline and blue/yellow dye. Quantitative analysis of the two-dimensional images can include determination of shade uniformity across the channel width in

different regions, as shown in other publications³⁸⁻⁴⁰. See **Supplementary Figure 1** for further details. See **Supplementary Figure 2** for demonstration of bubble handling by the microfluidic chip.

Results for particle detection in the optical block and sample loader demonstrations appear in **Figure 7C** and **D**, respectively. Optical block detection of fluorescently labeled white blood cells (**Fig. 7C**) appears relatively unperturbed by a transition from approximately 1.5 g to nearly zero-g, and continues during the transition back to 1.5 g. The sample loader data demonstrates that a sample was successfully loaded (here under lunar gravity conditions) and reached the optical block for detection (**Fig. 7D**). Quantitative analysis of the data reading utilizes a custom peak counting algorithm to compare counts and signal-to-noise ratio in reduced versus normal and high gravity conditions. See **Supplementary Figure 3** for extended traces and example analysis.

FIGURES:

Figure 1. Fluidics Subcomponents. (A) The candidate source vial uses a custom-machined aluminum cap fitted with two O-rings along its inserted portion. The cap screws down to the vial 'ring,' holding the cap firmly against the upper vial rim. (B) The candidate waste vial cap allows air but not fluid to pass through the cut opening in the top. (C) The candidate sample loader comprises individually machined head, center, and foot pieces, fit to two guiderails. Guiderail spacing facilitates capillary positioning. (D) A collected sample drop from a finger tip is loaded into the fluid line. (E) The candidate spiral-vortex micromixer mixes two solutions through a 3-rotation ('1', '2', '3') spiral (inner radii from 1.9 to 0.9 mm) and vortex drain ('V', diameter 320 μm). Fluid then passes via microbore tubing to an exit channel ('E'). Channels are 200 μm wide by 120 μm high. The height of the vortex drain (V) is 1-2 mm before meeting pin. (F) Chip footprint is comparatively smaller than a dime.

Figure 2. Optical and Electronic Subcomponents. (A) Candidate optical block component design includes two lasers ('Green' and 'Red') plus several beamsplitters ('BS'), lenses, and photon detectors ('PD'). (B) A solid modeled design (inset) is machined, anodized, and assembled. Stage (S), flow cell placement site (blue arrow), red laser (red arrow) are labeled. (C) For in-flight testing, the block is fixed using clamps and alignment fixtures, which also hold fiber optics feeding to photon counting modules. (D) Large DAQ boards and hand-soldered electronics are practical solutions before control/acquisition electronics can be reduced to microelectronic equivalents. The optical block (covered in a custom black acrylic box, unlabeled to the left) is visible in the photograph with an accelerometer ('Acc.') fixed on top. (E) Example custom software for the micromixer demonstration enables simultaneous device control, readouts, and data storage.

Figure 3. Test Rig Layout. (A) Flight environment may be crowded depending on how many groups are simultaneously running experiments in-flight. (B) Rig components are assembled on a vertical equipment rack divided between 3 levels. Leg straps (red and yellow) are visible in an arc around the rack. (C) The microscope breadboard plate is divided into 4 quadrants for demonstrations and placement of the electronics box.

Figure 4. Containment and Visualization. (A) A custom-fabricated acrylic 'glove' box enables the sample loader demonstration in-flight. Inner bins hold samples, capillaries, and waste. (B) A stereomicroscope fitted with a custom-fabricated microfluidic chip holder enables in-flight visualization of the micromixer demonstration. The microscope is modified with an extended neck to make space for the chip holder, which holds two chips simultaneously that can be quickly flipped between using a chip tray fitted with magnets to hold it in one of two positions. (C) A rig operator performs the sample loader demonstration while kneeling in-flight. A second operator operates a video camera to his left. (D) The micromixer is visible on the laptop.

Figure 5. Additional Components to Enable Demonstrations to Operate Via Simple Interventions. (A) The air pressure splitter consists of a partially hollowed and tapped cylinder to which a needle is adapted. Pressure outlets can be selectively clamped to reduce number of

outlet ports. **(B)** The panel of 12 three-way solenoid valves is controlled through the tandem MOSFET circuit in **(C)**.

Figure 6. In-Flight Demonstrations. The three-way solenoid valves have a common port (white arrow tip) that is always connected to either the default OFF port (red) or ON port (green). The switch to ON state is triggered with a 5-volt I/O signal. **(A)** The sample loader demonstration includes loading a sample and driving the sample to the optical block (OB) for detection. The setup utilizes two valves, one before and one after the loader. During loading, both valves are set to OFF, preventing fluid movement as the loader is utilized. Turning the valves ON opens the fluidics pathway extending from the saline (S) vial to the waste (W) vial, allowing the pump to drive the sample for analysis. **(B)** The transition from ‘manual’ to ‘1-button’ interventions in the optical block demonstration allows sequential testing of three different sample types — fluorescent counting beads (CB), a proprietary fluorescent hydrogel microparticle (NS), and fluorescently labeled WBCs — without a need to reconfigure tubing connections. Saline is able to flush the system between samples. Spl. = Air pressure splitter.

Figure 7. Representative Results. **(A)** Blue-yellow dye mixing under micro gravity conditions. **(B)** Blood-saline mixing under lunar gravity conditions. **(C)** WBC detection during microgravity flight. Critical performance metrics for the flow cytometry data include the coefficient of variation of the peak intensities, signal-to-noise ratios, peak counting rates, and detection efficiency. **(D)** Fluorescent counting beads spiked into a loaded sample are detected following demonstration of the loader in lunar gravity.

Supplementary Figure 1. Mixing analysis (blood-saline). **(A)** Mixing images are converted to grayscale and analyzed in the designated regions (inlet, spirals 1-3, and exit) per the equation $\sigma = \langle (I - \langle I \rangle)^2 \rangle^{1/2}$, where σ reflects the degree of mixing, I = grayscale intensity between 0 and 1, and $\langle \rangle$ is the average across the sample. This method reflects similar determinations in published literature³⁸⁻⁴⁰. For a completely mixed sample, σ equals zero. For an unmixed sample, σ equals 0.4 to 0.5. In practice, complete mixing when the sigma value is less than 0.1. This method, although sufficient for demonstration purposes, is limited because mixing is a 3-dimensional process and therefore requires 3-dimensional assessment (through confocal microscopy or other means) to fully describe the degree of mixing. **(B)** Blood-saline mixing results obtained in flight are displayed under different gravity conditions. The ‘high’ gravity graph was obtained during a micro gravity flight. Pump driving pressure setting increases from left to right in each graph.

Supplementary Figure 2. Demonstration of bubble handling. Two bubbles, one injected in high gravity and one injected in micro-gravity, are traced over time via video observation. Each bubble effectively clears the microfluidic chip. The performance contrasts with that of other ground-tested mixing geometries with a greater tendency to trap bubbles (data not shown). White arrows indicate air moving through the chip, which is difficult to distinguish from saline in the static images.

Supplementary Figure 3. Extended flow cytometry traces. Fluorescent counting bead **(A)** and white blood cell **(B)** detection traces recorded over 3 parabolas are shown. Detection rates (peaks/second) are displayed (white text) during high and low gravity periods as determined via custom software. Other critical metrics (e.g., coefficient of variation of peak intensity, signal-to-noise ratio) can be measured for insight into the effects of gravity on the fluidics and optical detection architecture.

DISCUSSION: The method described here enabled effective demonstration of the major technology components (sample loading, microfluidic mixing, and optical detection) during the 2010 FAST parabolic flights, with comparable results to ground testing. Training and SOP methods described here were particularly effective, and helped to illuminate tools and other ‘crutches’ being relied on for practice demonstrations that would not be available onboard the parabolic flight.

Areas for improvement include containment and layout. Custom acrylic components may not be sufficiently robust for containment purposes. The ‘glove’ box was struck by a passenger in-flight during a gravity transition and subsequently fell apart during a rough plane landing. Tubing connected to the microfluidic chip became unhooked during a blue-yellow dye mixing demonstration, briefly leaking food dye into the cabin environment. This needed to be fixed during a high-g interval, which was particularly difficult because reconnecting microbore tubing requires dexterity and user stability. In terms of layout, placement of the laptop at standing height made it difficult to operate during the high-g intervals. Users may become light-headed when attempting to stand during the high-g phases. A mid-level computer could be a better alternative, but here would have required displacement of prototype subcomponents. Other researchers have included seating in their parabolic flight setups for stabilization of test operators²⁶, although this requires additional space, which is scarce on parabolic flights.

In addition to providing a greater level of detail regarding preparation and setup compared to previous demonstrations of parabolic flight flow cytometry, this work describes inclusion of potentially significant ‘companion’ technology (i.e., the microfluidic chip for reagent mixing and sample dilution) alongside the cytometer. Sample pre-processing (e.g., fluorescent staining, mixing, incubation), as performed on the ground, may be difficult or hazardous in space, in turn making companion technologies, such as a mixing chip, necessary to achieve the same functions in reduced gravity. In contrast to the present work, previous demonstrations of potentially space-worthy flow cytometers have focused almost entirely on cytometry performance (using samples pre-processed on earth) and without indicated strategies to bridge the gaps in sample pre-processing. The described ‘fiber-optic-based’ flow cytometer, for example, used ground-loaded sample cartridges for immunophenotyping and microbead-based cytokine assays and it is not obvious how the system could be adapted for actual in-flight diagnostics. Some efforts have partially addressed the issue, including development of the whole blood staining device which has seen recent improvements⁴¹. The NASA-tested flow cytometer utilized a pre-staining method potentially usable with the whole blood staining device⁵. Still, efforts to develop necessary space-ready companion technology seem to lag sufficiently behind those to develop flow cytometers to keep flow cytometry impractical for

diagnostic purposes in space and other resource-limited environments in the near future. More generally, developers of *any* IVDs for outer space need to consider full workflow adaptation for their technology and should always consider testing of potentially necessary companion technology to take full advantage of limited reduced-gravity flight opportunities.

The described prototype flow cytometer is a starting point for a more sophisticated design, utilizing more advanced fluidics, optics, and electronics. The design presented here cannot effectively discriminate between different fluorescent entities (e.g., cell types, beads) because the detection is one-dimensional and being performed on samples that are floating freely through a wide channel (across which incident laser intensity is not constant). Differential cell counting could be achieved through implementation of hydrodynamic flow focusing combined with a second or third mode of detection (e.g., light scatter, absorption). Other components will need to be replaced simply because they are convenient in rig-based designs but would be impractical in actual handheld devices (e.g., waste vial, control/acquisition electronics). More advanced electronics would include microelectronics operated using a miniature screen interface and embedded microprocessors to eliminate the laptop and associated DAQ cards.

ACKNOWLEDGMENTS: Hardware development was supported by the NASA SBIR Contracts NNX09CA44C and NNX10CA97C. Data analysis for the optical block and sample loader demonstrations was supported by NASA Phase III Contract NNC11CA04C. The human blood collection was performed using NASA IRB Protocol # SA-10-008. Control/acquisition software provided through the National Instruments Medical Device Grant Program. Molds for the microchips were made at the Johns Hopkins microfabrication facility and the Harvard Center for Nanoscale Systems. Otto J. Briner and Luke Jaffe (DNA Medicine Institute) aided in rack assembly during summer 2010. NASA flight video staff provided video footage during flight week. Carlos Barrientos (DNA Medicine Institute) provided photograph and figure assistance. Special thanks to the Facilitated Access to the Space Environment for Technology 2010 Program, the NASA Reduced Gravity Office, the Human Adaptation and Countermeasures Division, NASA Glenn Research Center, ZIN Technologies, and the Human Research Program.

DISCLOSURES: Eugene Y. Chan, Candice Bae, and Julia Z. Sharpe are inventors on related technology patents filed through the DNA Medicine Institute, a commercial entity.

REFERENCES:

1. Thomas, R. A., Krishan, A., Robinson, D. M., Sams, C. & Costa, F. NASA/American Cancer Society High-Resolution Flow Cytometry Project-I. *Cytometry* **43**, 2–11 (2001).
2. Wen, J., Krishan, A. & Thomas, R. A. NASA/American Cancer Society High-Resolution Flow Cytometry Project - II. Effect of pH and DAPI concentration on dual parametric analysis of DNA/DAPI fluorescence and electronic nuclear volume. *Cytometry* **43**, 12–5 (2001).
3. Krishan, A., Wen, J., Thomas, R. A., Sridhar, K. S. & Smith, W. I. NASA/American Cancer Society High-Resolution Flow Cytometry Project - III. Multiparametric analysis of DNA content and electronic nuclear volume in human solid tumors. *Cytometry* **43**, 16–22 (2001).
4. Cram, L. S. Spin-offs from the NASA space program for tumor diagnosis. *Cytometry* **43**, 1

- (2001).
5. Crucian, B. & Sams, C. Reduced gravity evaluation of potential spaceflight-compatible flow cytometer technology. *Cytometry B Clin. Cytom.* **66** (1), 1–9, doi:10.1002/cyto.b.20057, (2005).
 6. Shi, W., Kasdan, H. L., Fridge, A., & Tai, Y.-C. Four-part differential leukocyte count using μ flow cytometer. *2010 IEEE 23rd International Conference on Micro Electro Mechanical Systems.* **13** (7), 1019–22, doi:10.1109/MEMSYS.2010.5442382, (2010).
 7. Tai, Y.-C., Ho, C.-M. & Kasdan, H. L. In-Flight Blood Analysis Technology for Astronaut Health Monitoring. NASA Human Research Program Investigators' Workshop (2010). Found at: <http://www.dsls.usra.edu/meetings/hrp2010/pdf/ExMC/1018Tai.pdf>.
 8. Shi, W., Guo, L. W., Kasdan, H., Fridge, A. & Tai, Y. Leukocyte 5-part differential count using a microfluidic cytometer. *2011 16th International Solid-State Sensors, Actuators and Microsystems Conference.* 2956–2959, doi:10.1109/TRANSDUCERS.2011.5969374, (2011).
 9. Shi, W., Guo, L., Kasdan, H., & Tai, Y.-C. Four-part leukocyte differential count based on sheathless microflow cytometer and fluorescent dye assay. *Lab Chip.* **13** (7), 1257–65, doi:10.1039/c3lc41059e, (2013).
 10. Dubeau-Laramée, G., Rivière, C., Jean, I., Mermut, O. & Cohen, L. Y. Microflow1, a sheathless fiber-optic flow cytometry biomedical platform: Demonstration onboard the international space station. *Cytometry A.* doi:10.1002/cyto.a.22427, (2013).
 11. NASA/JSC Aircraft Operations: C-9B Flight Trajectory. *NASA.gov.* Found at: http://jsc-aircraft-ops.jsc.nasa.gov/Reduced_Gravity/trajectory.html. Accessed on 04/23/2014.
 12. Crucian, B., Quiariarte, H., Guess, T., Ploutz-Snyder, R., McMonigal, K., & Sams, C. A Miniaturized Analyzer Capable of White-Blood-Cell and Differential Analyses During Spaceflight. *Lab Medicine.* **44** (4), 304–31, doi:10.1309/LMD3THAYCHICF2XT(2013), (2013).
 13. Rehnberg, L., Russomano, T., Falcão, F., Campos, F., & Everts, S. N. Evaluation of a novel basic life support method in simulated microgravity. *Aviat. Space. Environ. Med.* **82** (2), 104–10, doi: 10.3357/ASEM.2856.2011, (2011).
 14. Pump, B., Videbaek, R., Gabrielsen, A., & Norsk, P. Arterial pressure in humans during weightlessness induced by parabolic flights. *J. Appl. Physiol.* **87** (3), 928–32, (1999).
 15. Strauch, S. M., Richter, P., Schuster, M., & Häder, D. The beating pattern of the flagellum of *Euglena gracilis* under altered gravity during parabolic flights. *J. Plant Physiol.* **167** (1), 41–6, doi: 10.1016/j.jplph.2009.07.009, (2010).
 16. Sams, C. F., Crucian, B. E., Clift, V. L., & Meinelt, E. M. Development of a whole blood staining device for use during space shuttle flights. *Cytometry.* **37** (1), 74–80. (1999).
 17. Smith, S. M., Davis-Street, J. E., Fontenot, T. B. & Lane, H. W. Assessment of a portable clinical blood analyzer during space flight. *Clin. Chem.* **43**, 1056–65 (1997).
 18. Weigl, B. H., Kriebel, J., Mayes, K. J., Bui, T., & Yager, P. Whole Blood Diagnostics in Standard Gravity and Microgravity by Use of Microfluidic Structures (T-Sensors). *Microchimica Acta.* 131 (1-2), 75–83, doi: 10.1007/s006040050011, (1999).
 19. Revolutionizing Medical Technology for Earth and Space. *Canadian Space Agency.* Found at: <http://www.asc-csa.gc.ca/eng/media/backgrounders/2012/0229.asp> (2012).
 20. Peytavi, R. *et al.* Microfluidic device for rapid (<15 min) automated microarray hybridization. *Clin. Chem.* **51**, 1836–44 (2005).

21. Groemer, G. E., *et al.* The feasibility of laryngoscope-guided tracheal intubation in microgravity during parabolic flight: a comparison of two techniques. *Anesthesia and analgesia*. **101** (5), 1533–5, doi: 10.1213/01.ANE.0000181001.25777.53, (2005).
22. Johnston, S. L., Campbell, M. R., Billica, R. D., & Gilmore, S. M. Cardiopulmonary resuscitation in microgravity: efficacy in the swine during parabolic flight. *Aviat. Space Environ. Med.* **75** (6), 546–50 (2004).
23. Panait, L., Broderick, T., Rafiq, A., Speich, J., Doarn, C. R., & Merrell, R. C. Measurement of laparoscopic skills in microgravity anticipates the space surgeon. *Am. J. Surg.* **188** (5), 549–52, doi: 10.1016/j.amjsurg.2004.07.029, (2004).
24. Kirkpatrick, A. W., *et al.* Intraperitoneal gas insufflation will be required for laparoscopic visualization in space: a comparison of laparoscopic techniques in weightlessness. *J. Am. Coll. Surg.* **209** (2), 233–41, doi: 10.1016/j.jamcollsurg.2009.03.026, (2009).
25. Campbell, M. R., *et al.* Endoscopic surgery in weightlessness: the investigation of basic principles for surgery in space. *Surg. Endosc.* **15** (12), 1413–8, doi: 10.1007/s004640080178, (2001).
26. Caiani, E. G., Sugeng, L., Weinert, L., Capderou, A., Lang, R. M., & Vaïda, P. Objective evaluation of changes in left ventricular and atrial volumes during parabolic flight using real-time three-dimensional echocardiography. *J. Appl. Physiol.* **101** (2), 460–8, doi:10.1152/jappphysiol.00014.2006, (2006).
27. Ansari R, Manuel FK, Geiser M, Moret F, Messer RK, King JF, Suh KI, Measurement of choroidal blood flow in zero gravity, in *Ophthalmic technologies XII : 19-20 January 2002, San Jose, USA*, F. Manns, P.G. S derberg, and A. Ho, Editors. 2002; SPIE: Bellingham, Wash. 4951:177-184.
28. Foldager, N., *et al.* Central venous pressure in humans during microgravity. *J. Appl. Physiol.* **81** (1), 408–12 (1996).
29. Hausmann, N. *et al.* Cytosolic calcium, hydrogen peroxide and related gene expression and protein modulation in Arabidopsis thaliana cell cultures respond immediately to altered gravitation: parabolic flight data. *Plant Biol. (Stuttg)*. **16 Suppl 1**, 120–8 (2014).
30. Thiel, C. S., *et al.* Rapid alterations of cell cycle control proteins in human T lymphocytes in microgravity. *Cell Commun. Signal.* **10** (1), 1, doi:10.1186/1478-811X-10-1, (2012).
31. Tsuda, T., Kitagawa, S., & Yamamoto, Y. Estimation of electrophoretic mobilities of red blood cells in 1-G and microgravity using a miniature capillary electrophoresis unit. *Electrophoresis*. **23** (13), 2035–9, doi:10.1002/1522-2683(200207)23:13<2035::AID-ELPS2035>3.0.CO;2-C, (2002).
32. Paul, A.-L., Manak, M. S., Mayfield, J. D., Reyes, M. F., Gurley, W. B., & Ferl, R. J. Parabolic flight induces changes in gene expression patterns in Arabidopsis thaliana. *Astrobiology*. **11** (8), 743–58, doi: 10.1089/ast.2011.0659, (2011).
33. Zeredo, J. L., Toda, K., Matsuura, M., & Kumei, Y. Behavioral responses to partial-gravity conditions in rats. *Neurosci. Lett.* **529** (2), 108–11, doi:10.1016/j.neulet.2012.09.043 (2012).
34. Taube, J. S., Stackman, R. W., Calton, J. L., & Oman, C. M. Rat head direction cell responses in zero-gravity parabolic flight. *J. Neurophysiol.* **92** (5), 2887–97, doi:10.1152/jn.00887.2003, (2004).
35. Hilbig, R., *et al.* Effects of altered gravity on the swimming behaviour of fish. *Adv. Space*

- Res. **30** (4), 835–41 (2002).
36. 2010 FAST Flight Week. *Nasa.gov: Office of the Chief Technologist*. Found at: http://www.nasa.gov/offices/oct/crosscutting_capability/flight_opportunities/fast/09_27_10_flight_week_feature.html. Accessed 04/28/2014.
 37. Deng J., Harvard Center for Nanoscale Systems Standard Operating Procedure: SOP031 (SU-8 Photolithography Process), Vers. 2.6. Found at: http://www.cns.fas.harvard.edu/facilities/docs/SOP031_r2_6_SU-8%20photolithography%20process.pdf.
 38. Yang, J., Qi, L., Chen, Y. & Ma, H. Design and Fabrication of a Three Dimensional Spiral Micromixer. *Chinese J. Chem.* **31**, 209–214, 10.1002/cjoc.201200922, (2013).
 39. Zhang, K. *et al.* Realization of planar mixing by chaotic velocity in microfluidics. *Microelectron. Eng.* **88**, 959–963, doi:10.1016/j.mee.2010.12.029, (2011).
 40. Liu, R. H. *et al.* Passive mixing in a three-dimensional serpentine microchannel. *J. Microelectromechanical Syst.* **9**, 190–197, doi: [10.1109/84.846699](https://doi.org/10.1109/84.846699), (2000).
 41. Improved Whole-Blood-Staining Device. *NASA Tech Briefs*. Found at: <http://www.techbriefs.com/component/content/article/10-ntb/tech-briefs/bio-medical/13574>. Accessed: 04/28/2014.

-

Figure 1
[Click here to download Figure: Figure 1.pdf](#)

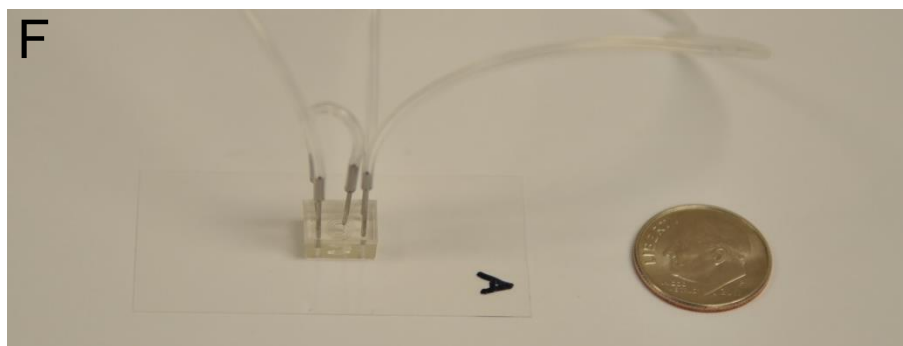
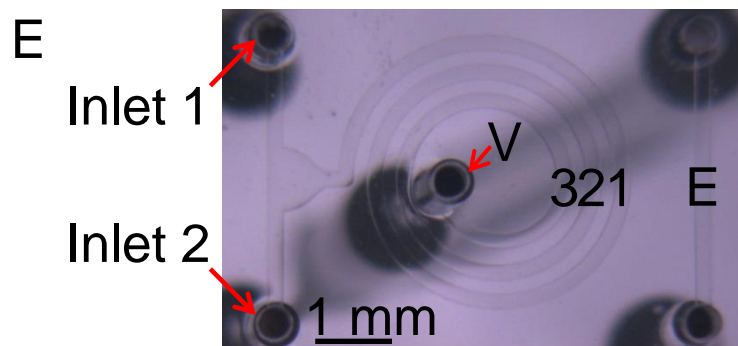
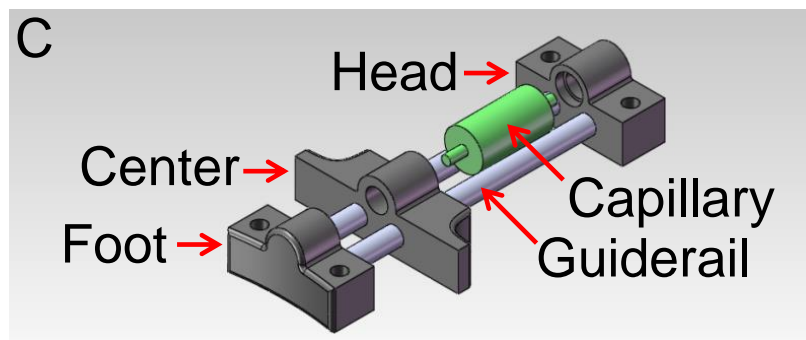
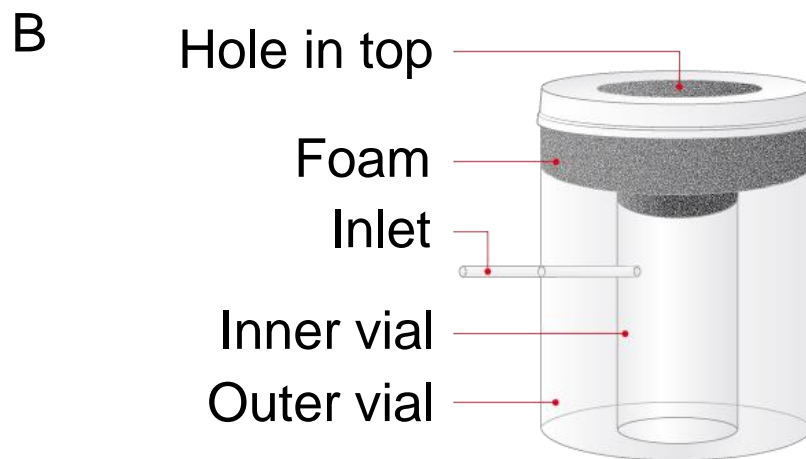
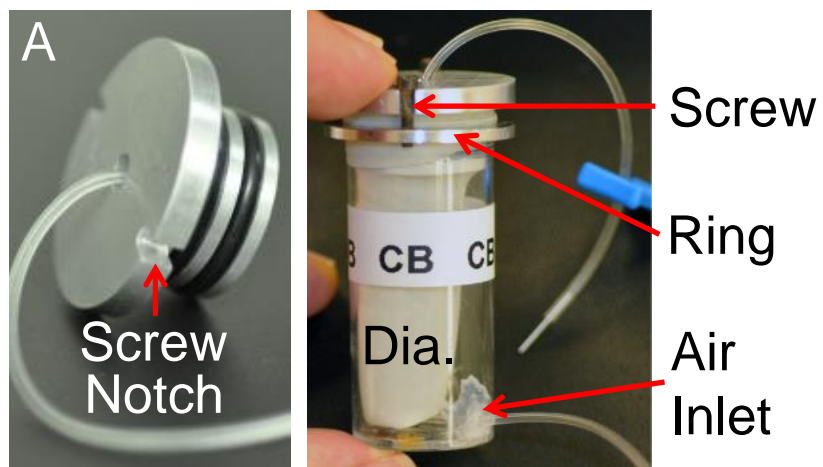

Figure 2
[Click here to download Figure: Figure 2.pdf](#)

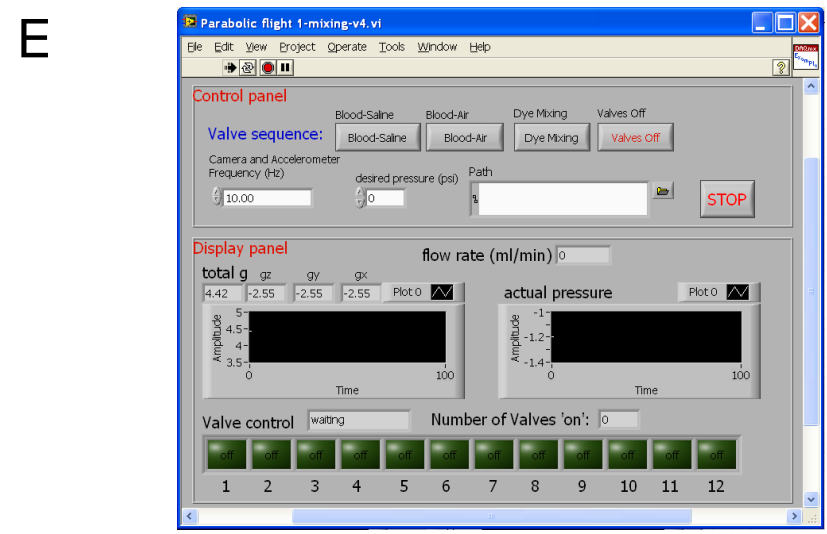
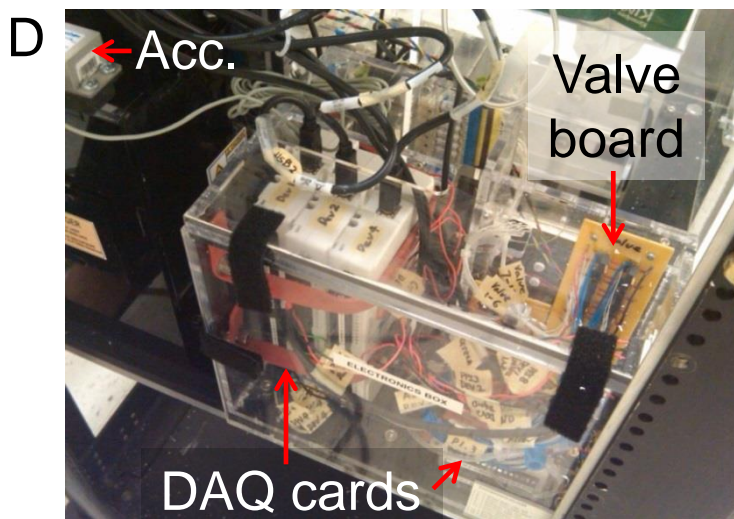
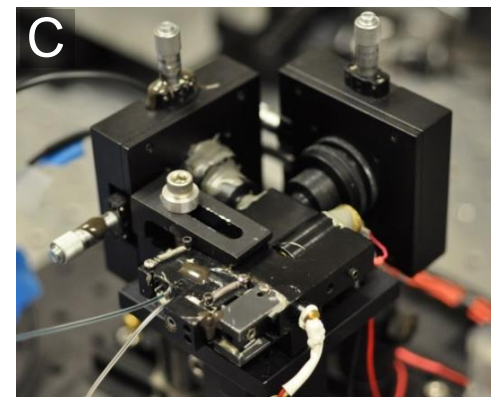
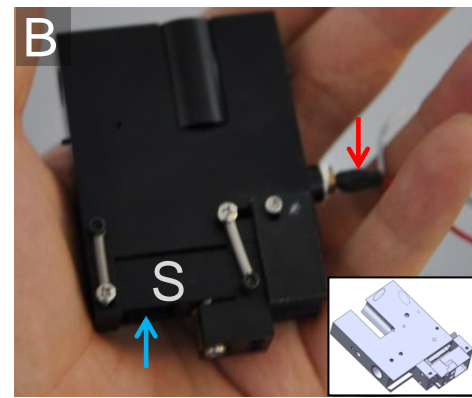
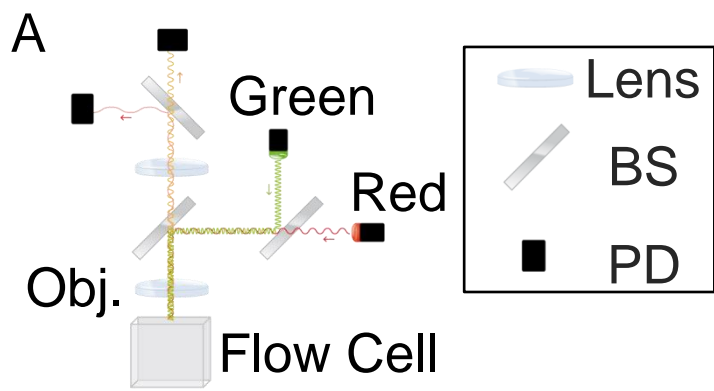
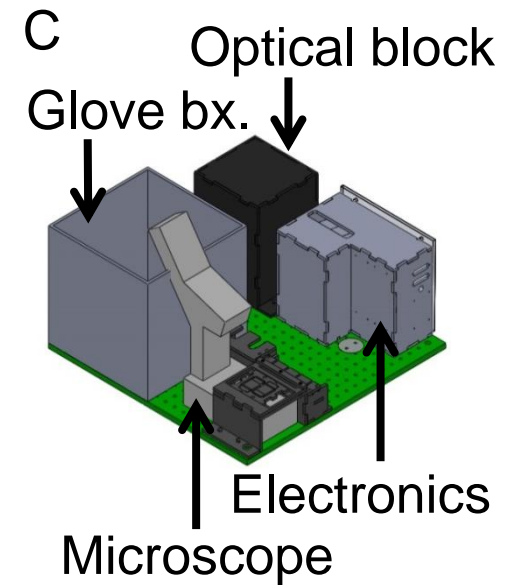
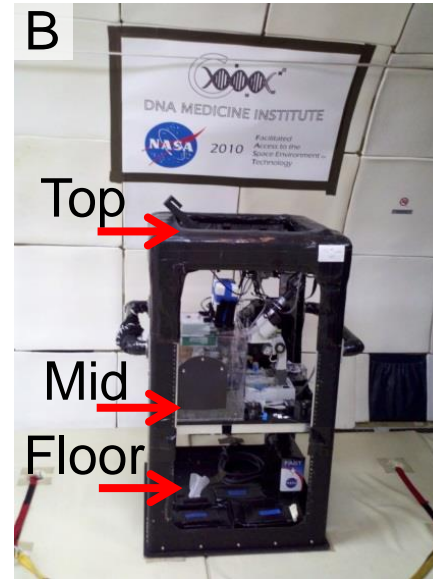

Figure 3
[Click here to download Figure: Figure 3.pdf](#)



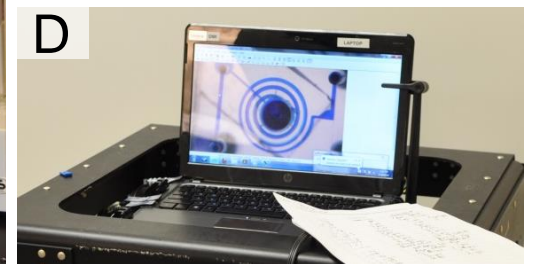
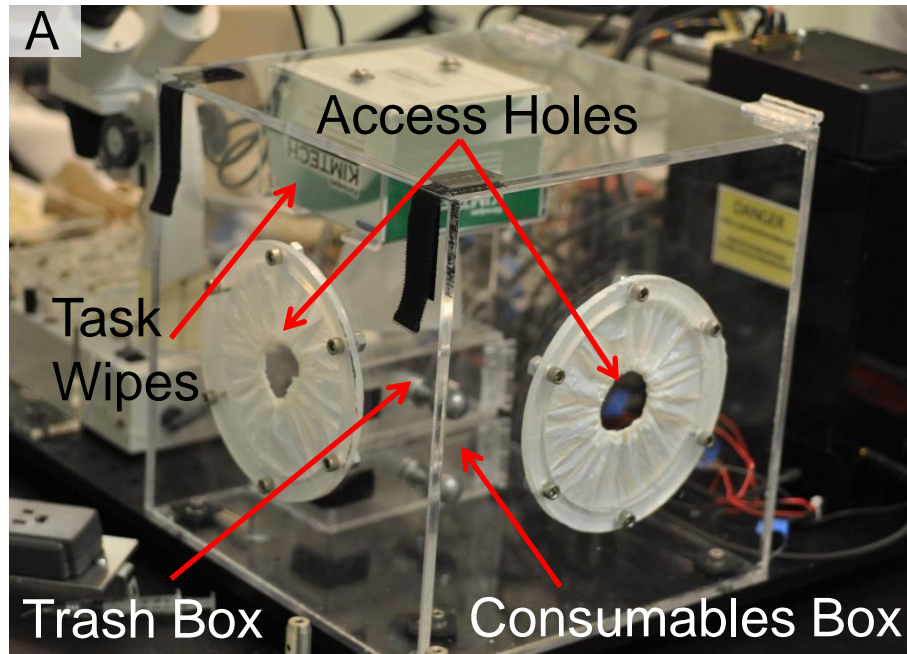

Figure 5
[Click here to download Figure: Figure 5.pdf](#)

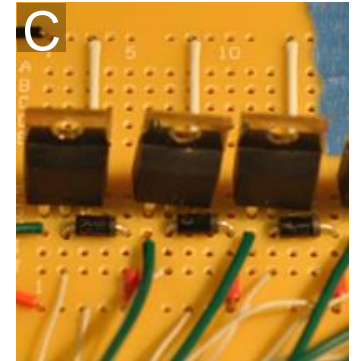
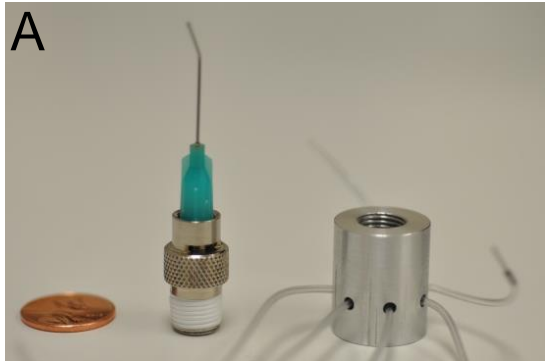

Figure 6
Click here to download Figure: Figure 6.pdf

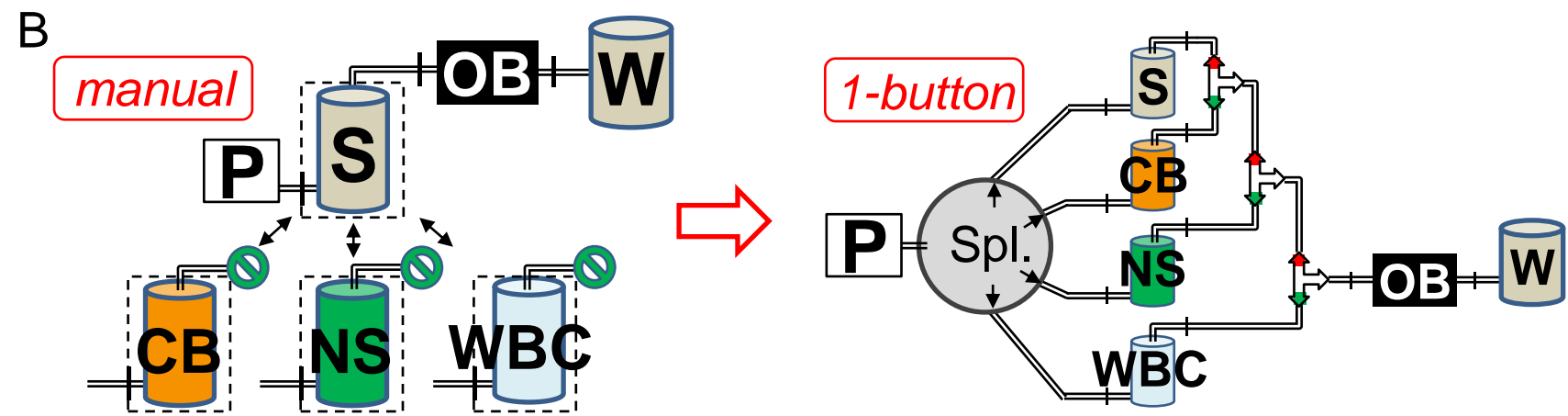
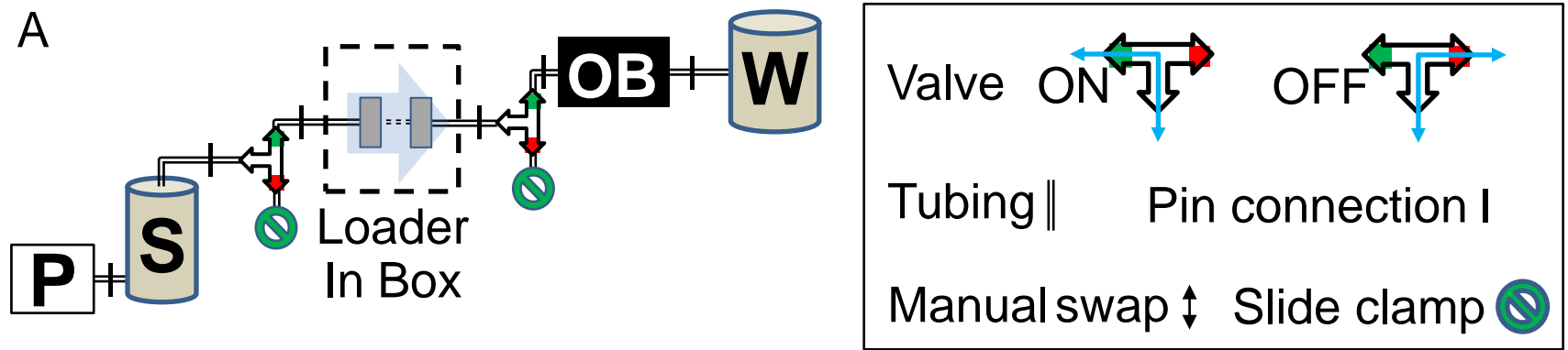
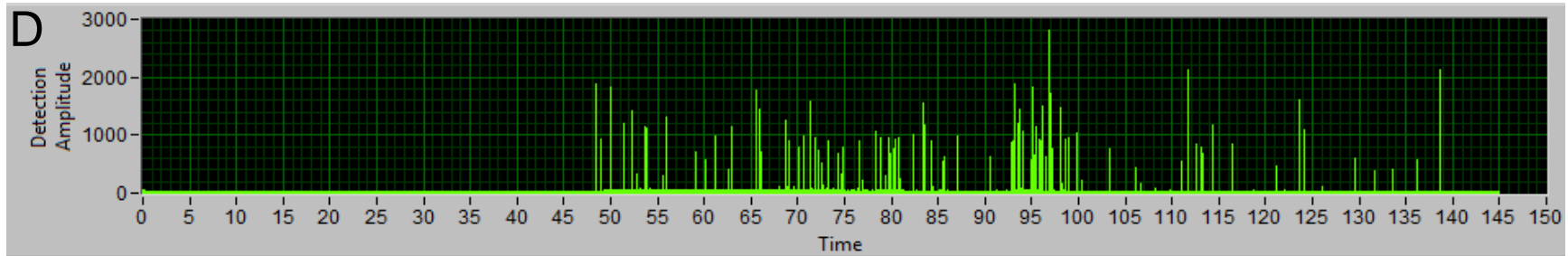
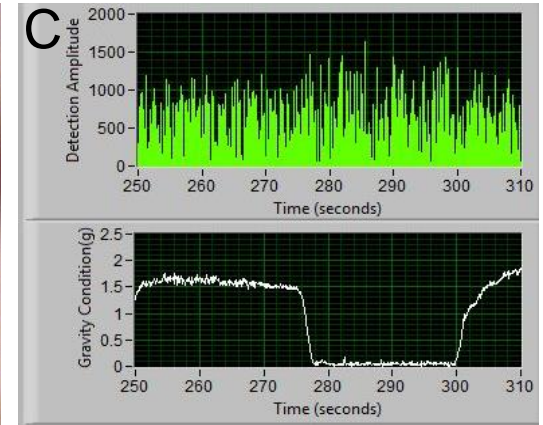
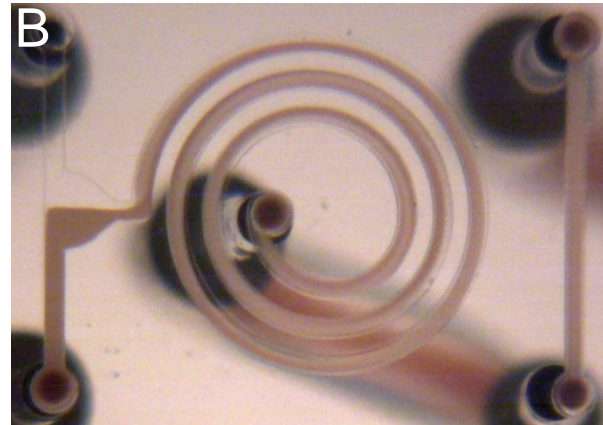
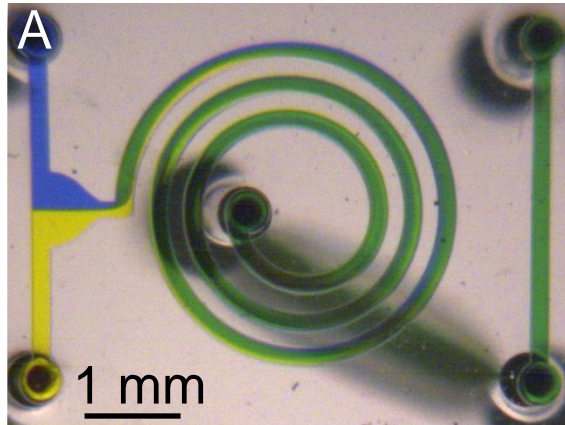
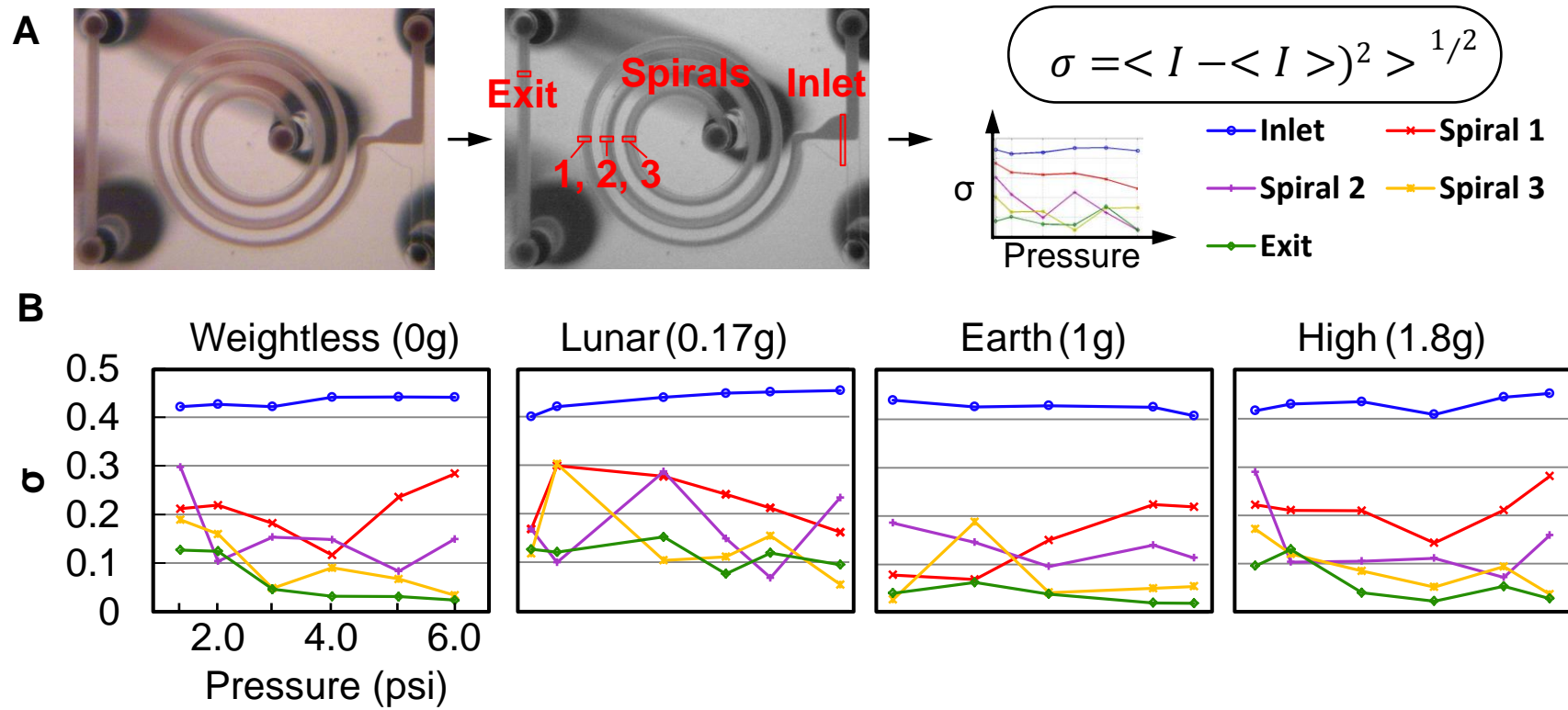
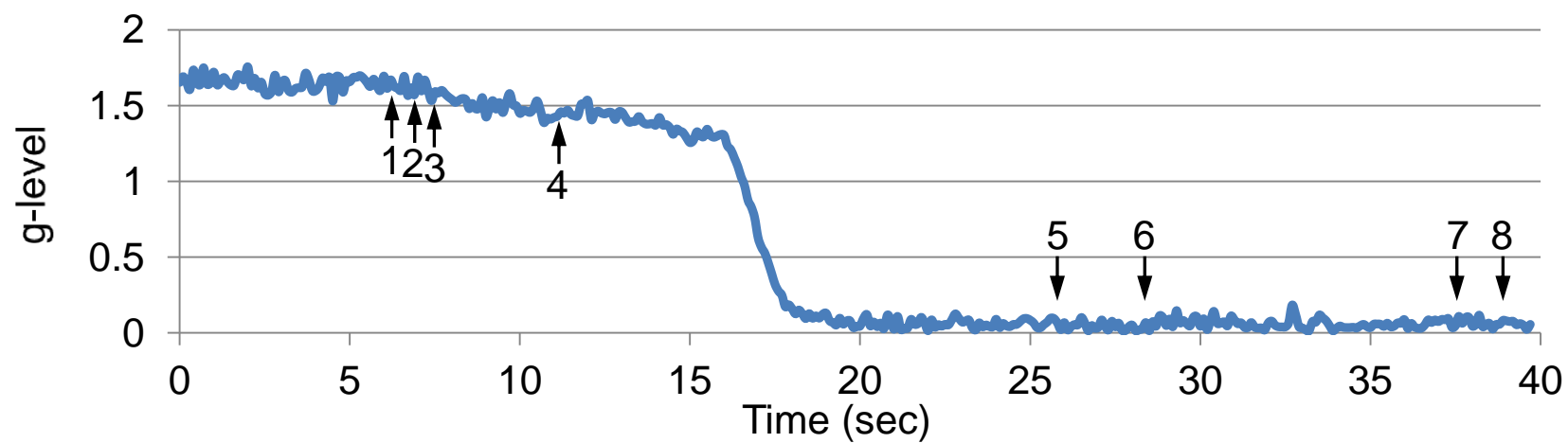
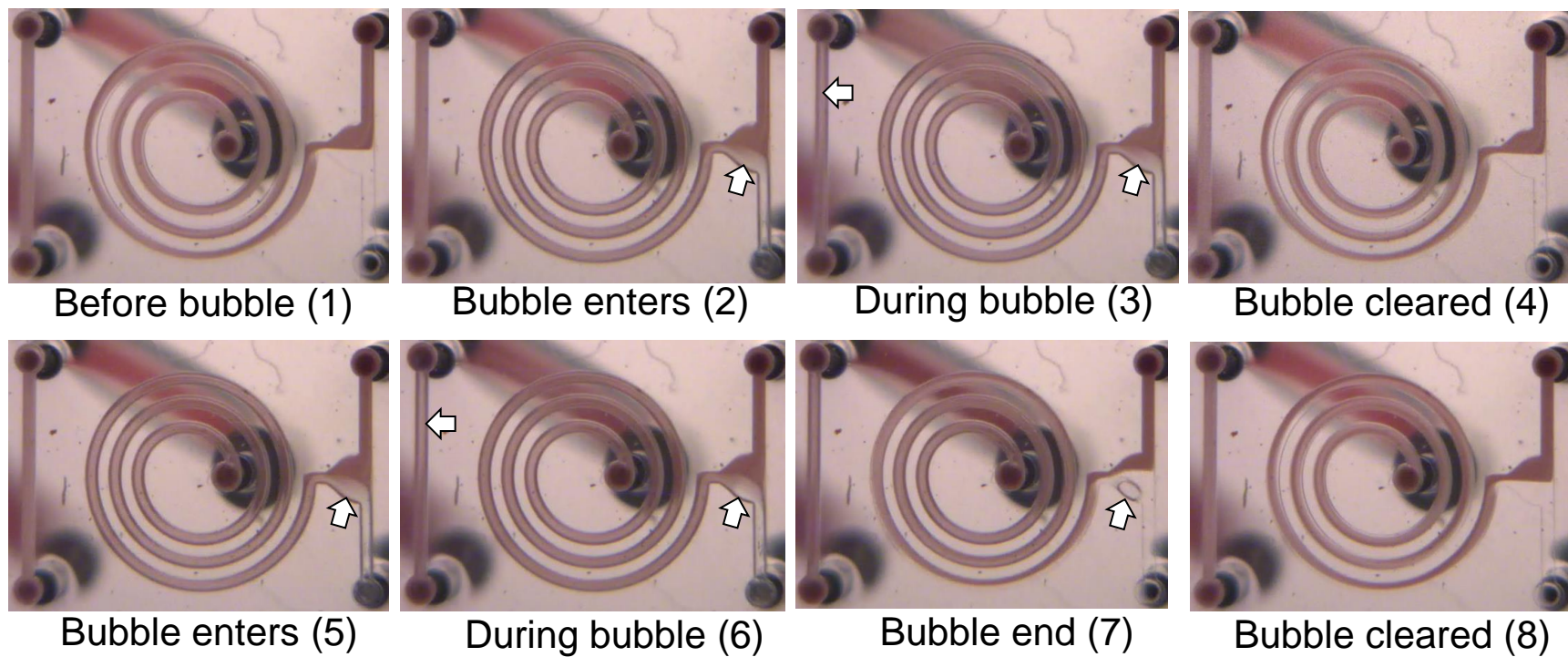

Figure 7
[Click here to download Figure: Figure 7.pdf](#)







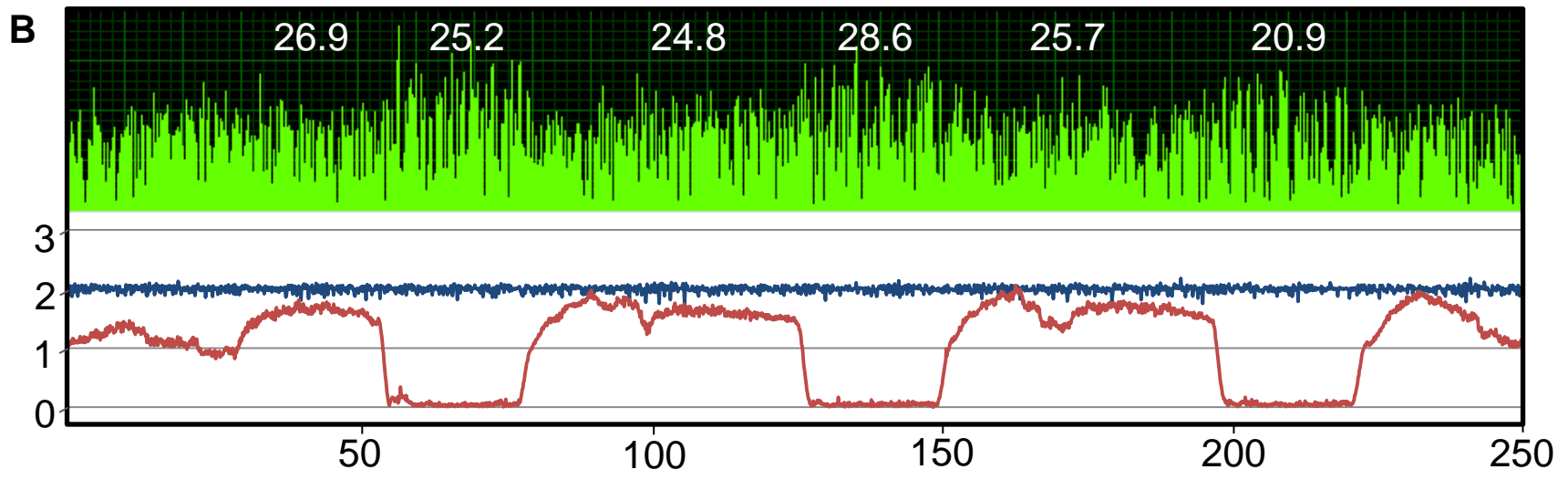
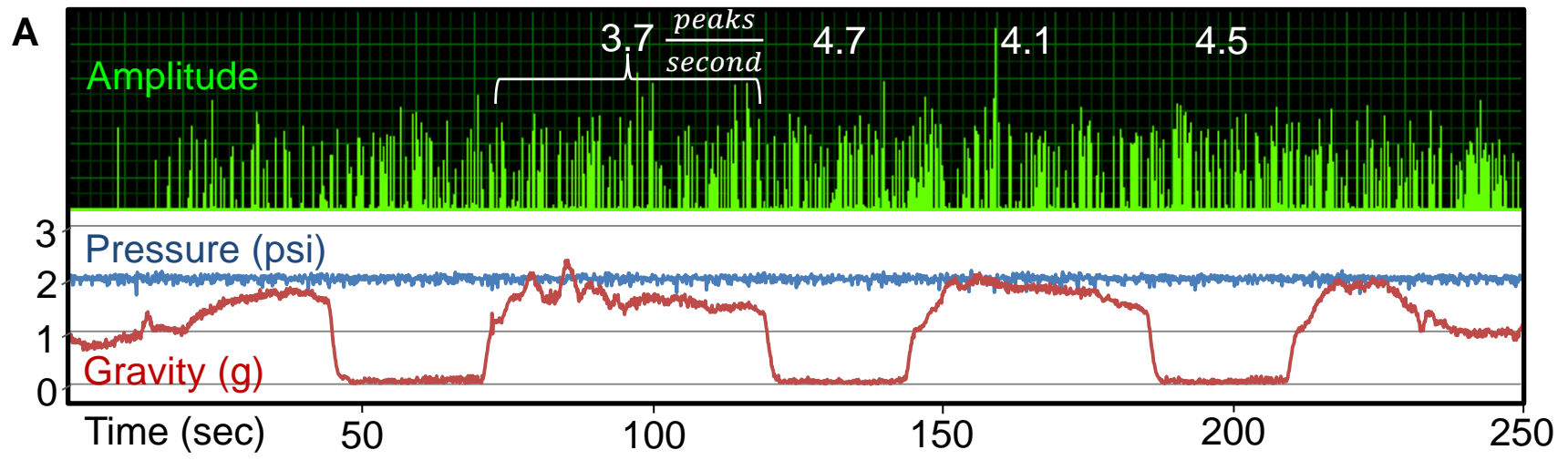

Table 1. Parabolic Flight Demonstration Examples with Well Described Methods/ Equipment

Category	Examples
Emergency medical care	Tracheal intubation (laryngoscope-guided, on manikin) ²¹ , cardiac life support (anesthetized pigs) ²²
Surgical care	Laparoscopic surgery (video simulated ²³ , on anesthetized pigs ^{24,25})
Medical imaging or physiology assessment	Ultrasound with lower body negative pressure chamber ²⁶ , Doppler flowmeter (head mounted) ²⁷ , central venous pressure monitor ²⁸
Specialized biological equipment	Microplate reader (and in-flight glove box) ²⁹ , temperature control system for cell cycle experiments ³⁰ , microscope (brightfield, phase contrast, and multi-channel fluorescence capable) ¹⁵ , capillary electrophoresis unit coupled to video microscope ³¹
Other	Plant harvesting with forceps ³² , contained rats ^{33,34} and fish ³⁵ for observation

Name of Material/ Equipment	Company	Catalog Number
Micro air pump	Smart Products, Inc.	AP-2P02A
Differential pressure sensor	Honeywell International, Inc.	ASDX015D44R
Rigid plastic vial (small size)	Loritz & Associates, Inc.	55-05
Rigid plastic vial (larger size)	Loritz & Associates, Inc.	55-140
latex examination gloves	dynarex corporation	2337
Optical glue	Norland Products	NOA 88
3-way solenoid valves	The LEE Company	LHDA0531115H
Volumetric water flowmeter	OMEGA Engineering inc.	FLR-1602A
PCD-mini photon detector	Sensl	PCDMini-00100
Accelerometer	Crossbow Technology, Inc.	CXL02LF3
Stereomicroscope	AmScope	SE305R-AZ-E
CCD Camera	Thorlabs	DCU223C
USB and Trigger Cable (In/Out) for CCD Camera	Thorlabs	CAB-DCU-T1
Microbore tubing	Saint-Gobain Corporation	AAD04103
Hollow steel pins	New England Small Tube	(Custom)
Slide clamp	World Precision Instruments, Inc.	14042
Leur adaptor pieces	World Precision Instruments, Inc.	14011
Silicon wafer	Addison Engineering, Inc.	
Polydimethylsiloxane (PDMS) elastomer base	Dow Corning	3097366-1004
Polydimethylsiloxane (PDMS) elastomer curing agent	Dow Corning	3097358-1004
Needle (23 gauge), bevel tip	Terumo Medical Corporation	NN-2338R
Dispensing needle (23 gauge), blunt tip	CML Supply	901-23-100
Rotary tool	Robert Bosch Tool Corporation	1100-01
Cover glass	Thermo Fisher Scientific, Inc.	12-518-105E
Vacuum pump	Mountain	MTN8407
Vacuum chamber	Thermo Fisher Scientific, Inc.	5311-0250
Plasma cleaner	Harrick Plasma	PDC-32G
Hand magnifier	Mitutoyo	183-131
Ethanol	CAROLINA	861283
Water purification system	Thermo Fisher Scientific, Inc.	D11901
Optomechanical translation mounts	Thorlabs	K6X
Laptop	Hewlett-Packard	VP209AV

Laptop tray (spring loaded)	National Products, INC.	RAM-234-3
USB splitter	Connectland Technology Limited	3401167
USB Data Acquisition Cards (8 analog input, 12 digital I/O)	National Instruments	NI USB-6008
USB Data Acquisition Cards (16 analog input, 32 digital I/O)	National Instruments	NI USB-6216
Control/acquisition Software	National Instruments	LabVIEW 2009
3D Solid Modeling Software	Dassault Systèmes SolidWorks Corp.	SolidWorks 2011
2D Modeling Software	AUTODESK	AutoCAD LT 2008
Vertical equipment rack	(NASA provided)	N/A
Solid aluminum optical breadboard	Thorlabs	MB2424
Industrial grade steel and hardener	The J-B Weld Company	
Micro-hematocrit capillary	Fisher Scientific	22-362-574
1 mL syringes	Henke-Sass, Wolf	4010.200V0
Human red blood cells	Innovative Research	IPLA-WB3
Phosphate buffered saline concentrate	P5493	SIGMA
Tween	P9416	SIGMA
Centrifuge	LW Scientific	STRAIGHT8-5K
HD video recorder	Sony	MHS-CM5
Orange fluorescent nucleic acid stain	Invitrogen	S-11364
Fluorescent counting beads	Invitrogen	MP 36950

Comments/Description

Max pressure = 6.76 psi; 1.301" x 0.394" x 0.650" , 0.28 oz (8 g); available direct from Smart Products

Range of 0-15psi; 0.974" x 0.550" x 0.440", 0.09 oz (2.565 g); suppliers include Digi-Key and Mouser Electronics

Polystyrene; ID 0.81" (20.6 mm), IH 2.06" (52.4 mm); available direct from LA Container Inc.; similar product available from Dynalab Corp.

Polystyrene; ID 1.88" (47.6 mm), IH 3.31" (84.1 mm); available direct from LA Container Inc.; similar product available from Dynalab Corp.

Middle finger used for latex diaphragm in fluid source vial. Other brands (e.g., Aurelia[®] Vibrant[™]) acceptable.

Low outgassing adhesive; available direct from Norland; Also available from Edmund Optics Inc.

Gas valves, but can function with liquid; 1.29 " L, 0.28 " D. Discontinued product. Similar products available from The LEE Company.

Non-contacting flow rate meter strongly preferred. We recommend SENSIRION LG16 OEM Liquid Flow Sensor for flow rates from nl/min up to

For fluorescence detection; available direct from Sensi

3-dimensional force detection. Supplied to DMI by NASA. Similar product available from Vernier Software & Technology, LLC.

1024 x 768 Resolution, Color, USB 2.0; available direct from Thorlabs

Available direct from Thorlabs

Tygon[®]; ID 0.02", OD 0.06", 500ft, 0.02" wall. Suppliers: VWR, Thermo Fisher Scientific Inc.

0.025" OD, 0.017" ID, 0.500" L, stainless steel tube, type 304, cut, deburred, passivated; enable microbore tubing connections, chip tubing cc

Available direct from World Precision Instruments

Available direct from World Precision Instruments

6" diameter; for SU-8 mold fabrication

Supplier: Global Industrial SLP, LLC

Supplier: Global Industrial SLP, LLC

Ultra thin wall; 23G x 1.5"; 22G also usable; suppliers: Careforde, Inc., Port City Medical

23Gx 1"; available from CML Supply

Dremel[®] 1100-01 Stylus[™]

Gold Seal[™] noncorrosive borosilicate glass; for PDMS chip cover; 24x60 mm; available from Thermo Fisher Scientific, Inc.

For degassing PDMS; supplier: Ryder System, Inc.

Nalgene[™] Transparent Polycarbonate; available from Thermo Fisher Scientific, Inc.

Use in reverse direction to enable viewing at ~15".

For chip cleaning. Dilute to 70% using millipore water.

Available direct from Thermo Fisher Scientific, Inc.

6-Axis Kinematic Optic Mount; discontinued product; new product (K6XS) available direct from Thorlabs

HP Pavilion Laptop running Windows 7

RAM Tough-Tray™. Can accommodate 10 to 16 inch wide laptops.

12-Bit, 10 kS/s Low-Cost Multifunction DAQ
16-Bit, 400 kS/s Isolated M Series MIO DAQ, Bus-Powered
Custom coded National Instruments (NI) LabVIEW

24" x 24" x 1/2", 1/4"-20 Taps; available direct from Thorlabs

J-B Weld Steel Reinforced Epoxy Glue

inner diameter 1.1 to 1.2 mm

NORM-JECT®; supplier: Grainger, Inc.

Tested and found negative by supplier for: HBsAg, HCV, HIV-1, HIV-2, HIV-1Ag or HIV 1-NAT, ALT, and syphilis by FDA-Approved Methods.

Because no test methods can guarantee with 100% certainty the absence of an infectious agent, human derived products should be handled as suggested in the U.S. Department of Health and Human Services Manual on BIOSAFETY IN MICROBIOLOGICAL AND BIOMEDICAL LABORATORIES. FOR POTENTIALLY INFECTIOUS HUMAN SERUM OR BLOOD SPECIMENS

10x; diluted to 1x

TWEEN® 20

Swing-Out 8-place Centrifuge. Available through authorized dealers. Other centrifuges available direct from LW Scientific.

SYTO® 83 Orange Fluorescent Nucleic Acid Stain. Stored in DMSO solvent. Always wear recommended Personal Protective Equipment. No special handling

advice required.

CountBright™ Absolute Counting Beads. Always wear recommended Personal Protective Equipment. No special handling advice required.

to 5 ml/min.

connections

ARTICLE AND VIDEO LICENSE AGREEMENT

Title of Article:

Author(s):

Item 1 (check one box): The Author elects to have the Materials be made available (as described at <http://www.jove.com/publish>) via: Standard Access Open Access

Item 2 (check one box):

- The Author is NOT a United States government employee.
- The Author is a United States government employee and the Materials were prepared in the course of his or her duties as a United States government employee.
- The Author is a United States government employee but the Materials were NOT prepared in the course of his or her duties as a United States government employee.

ARTICLE AND VIDEO LICENSE AGREEMENT

1. **Defined Terms.** As used in this Article and Video License Agreement, the following terms shall have the following meanings: **"Agreement"** means this Article and Video License Agreement; **"Article"** means the article specified on the last page of this Agreement, including any associated materials such as texts, figures, tables, artwork, abstracts, or summaries contained therein; **"Author"** means the author who is a signatory to this Agreement; **"Collective Work"** means a work, such as a periodical issue, anthology or encyclopedia, in which the Materials in their entirety in unmodified form, along with a number of other contributions, constituting separate and independent works in themselves, are assembled into a collective whole; **"CRC License"** means the Creative Commons Attribution-Non Commercial-No Derivs 3.0 Unported Agreement, the terms and conditions of which can be found at: <http://creativecommons.org/licenses/by-nc-nd/3.0/legalcode>; **"Derivative Work"** means a work based upon the Materials or upon the Materials and other pre-existing works, such as a translation, musical arrangement, dramatization, fictionalization, motion picture version, sound recording, art reproduction, abridgment, condensation, or any other form in which the Materials may be recast, transformed, or adapted; **"Institution"** means the institution, listed on the last page of this Agreement, by which the Author was employed at the time of the creation of the Materials; **"JoVE"** means MyJoVE Corporation, a Massachusetts corporation and the publisher of *The Journal of Visualized Experiments*; **"Materials"** means the Article and / or the Video; **"Parties"** means the Author and JoVE; **"Video"** means any video(s) made by the Author, alone or in conjunction with any other parties, or by JoVE or its affiliates or agents, individually or in collaboration with the Author or any other parties, incorporating all or any portion of the Article, and in which the Author may or may not appear.

2. **Background.** The Author, who is the author of the Article, in order to ensure the dissemination and protection of the Article, desires to have the JoVE publish the Article and create and transmit videos based on the Article. In furtherance of such goals, the Parties desire to memorialize in this Agreement the respective rights of each Party in and to the Article and the Video.

3. **Grant of Rights in Article.** In consideration of JoVE agreeing to publish the Article, the Author hereby grants to JoVE, subject to **Sections 4** and **7** below, the exclusive, royalty-free, perpetual (for the full term of copyright in the Article, including any extensions thereto) license (a) to publish, reproduce, distribute, display and store the Article in all forms, formats and media whether now known or hereafter developed (including without limitation in print, digital and electronic form) throughout the world, (b) to translate the Article into other languages, create adaptations, summaries or extracts of the Article or other Derivative Works (including, without limitation, the Video) or Collective Works based on all or any portion of the Article and exercise all of the rights set forth in (a) above in such translations, adaptations, summaries, extracts, Derivative Works or Collective Works and (c) to license others to do any or all of the above. The foregoing rights may be exercised in all media and formats, whether now known or hereafter devised, and include the right to make such modifications as are technically necessary to exercise the rights in other media and formats. If the "Open Access" box has been checked in **Item 1** above, JoVE and the Author hereby grant to the public all such rights in the Article as provided in, but subject to all limitations and requirements set forth in, the CRC License.

4. **Retention of Rights in Article.** Notwithstanding the exclusive license granted to JoVE in **Section 3** above, the

ARTICLE AND VIDEO LICENSE AGREEMENT

Author shall, with respect to the Article, retain the non-exclusive right to use all or part of the Article for the non-commercial purpose of giving lectures, presentations or teaching classes, and to post a copy of the Article on the Institution's website or the Author's personal website, in each case provided that a link to the Article on the JoVE website is provided and notice of JoVE's copyright in the Article is included. All non-copyright intellectual property rights in and to the Article, such as patent rights, shall remain with the Author.

5. Grant of Rights in Video – Standard Access. This **Section 5** applies if the "Standard Access" box has been checked in **Item 1** above or if no box has been checked in **Item 1** above. In consideration of JoVE agreeing to produce, display or otherwise assist with the Video, the Author hereby acknowledges and agrees that, Subject to **Section 7** below, JoVE is and shall be the sole and exclusive owner of all rights of any nature, including, without limitation, all copyrights, in and to the Video. To the extent that, by law, the Author is deemed, now or at any time in the future, to have any rights of any nature in or to the Video, the Author hereby disclaims all such rights and transfers all such rights to JoVE.

6. Grant of Rights in Video – Open Access. This **Section 6** applies only if the "Open Access" box has been checked in **Item 1** above. In consideration of JoVE agreeing to produce, display or otherwise assist with the Video, the Author hereby grants to JoVE, subject to **Section 7** below, the exclusive, royalty-free, perpetual (for the full term of copyright in the Article, including any extensions thereto) license (a) to publish, reproduce, distribute, display and store the Video in all forms, formats and media whether now known or hereafter developed (including without limitation in print, digital and electronic form) throughout the world, (b) to translate the Video into other languages, create adaptations, summaries or extracts of the Video or other Derivative Works or Collective Works based on all or any portion of the Video and exercise all of the rights set forth in (a) above in such translations, adaptations, summaries, extracts, Derivative Works or Collective Works and (c) to license others to do any or all of the above. The foregoing rights may be exercised in all media and formats, whether now known or hereafter devised, and include the right to make such modifications as are technically necessary to exercise the rights in other media and formats. For any Video to which this Section 6 is applicable, JoVE and the Author hereby grant to the public all such rights in the Video as provided in, but subject to all limitations and requirements set forth in, the CRC License.

7. Government Employees. If the Author is a United States government employee and the Article was prepared in the course of his or her duties as a United States government employee, as indicated in **Item 2** above, and any of the licenses or grants granted by the Author hereunder exceed the scope of the 17 U.S.C. 403, then the rights granted hereunder shall be limited to the maximum rights permitted under such statute. In such case, all provisions contained herein that are not in conflict with such statute shall remain in full force and effect, and all provisions contained herein that do so conflict

shall be deemed to be amended so as to provide to JoVE the maximum rights permissible within such statute.

8. Likeness, Privacy, Personality. The Author hereby grants JoVE the right to use the Author's name, voice, likeness, picture, photograph, image, biography and performance in any way, commercial or otherwise, in connection with the Materials and the sale, promotion and distribution thereof. The Author hereby waives any and all rights he or she may have, relating to his or her appearance in the Video or otherwise relating to the Materials, under all applicable privacy, likeness, personality or similar laws.

9. Author Warranties. The Author represents and warrants that the Article is original, that it has not been published, that the copyright interest is owned by the Author (or, if more than one author is listed at the beginning of this Agreement, by such authors collectively) and has not been assigned, licensed, or otherwise transferred to any other party. The Author represents and warrants that the author(s) listed at the top of this Agreement are the only authors of the Materials. If more than one author is listed at the top of this Agreement and if any such author has not entered into a separate Article and Video License Agreement with JoVE relating to the Materials, the Author represents and warrants that the Author has been authorized by each of the other such authors to execute this Agreement on his or her behalf and to bind him or her with respect to the terms of this Agreement as if each of them had been a party hereto as an Author. The Author warrants that the use, reproduction, distribution, public or private performance or display, and/or modification of all or any portion of the Materials does not and will not violate, infringe and/or misappropriate the patent, trademark, intellectual property or other rights of any third party. The Author represents and warrants that it has and will continue to comply with all government, institutional and other regulations, including, without limitation all institutional, laboratory, hospital, ethical, human and animal treatment, privacy, and all other rules, regulations, laws, procedures or guidelines, applicable to the Materials, and that all research involving human and animal subjects has been approved by the Author's relevant institutional review board.

10. JoVE Discretion. If the Author requests the assistance of JoVE in producing the Video in the Author's facility, the Author shall ensure that the presence of JoVE employees, agents or independent contractors is in accordance with the relevant regulations of the Author's institution. If more than one author is listed at the beginning of this Agreement, JoVE may, in its sole discretion, elect not take any action with respect to the Article until such time as it has received complete, executed Article and Video License Agreements from each such author. JoVE reserves the right, in its absolute and sole discretion and without giving any reason therefore, to accept or decline any work submitted to JoVE. JoVE and its employees, agents and independent contractors shall have full, unfettered access to the facilities of the Author or of the Author's institution as necessary to make the Video, whether actually published or not. JoVE has sole discretion as to the method of making and publishing the Materials, including,

ARTICLE AND VIDEO LICENSE AGREEMENT

without limitation, to all decisions regarding editing, lighting, filming, timing of publication, if any, length, quality, content and the like.

11. **Indemnification.** The Author agrees to indemnify JoVE and/or its successors and assigns from and against any and all claims, costs, and expenses, including attorney's fees, arising out of any breach of any warranty or other representations contained herein. The Author further agrees to indemnify and hold harmless JoVE from and against any and all claims, costs, and expenses, including attorney's fees, resulting from the breach by the Author of any representation or warranty contained herein or from allegations or instances of violation of intellectual property rights, damage to the Author's or the Author's institution's facilities, fraud, libel, defamation, research, equipment, experiments, property damage, personal injury, violations of institutional, laboratory, hospital, ethical, human and animal treatment, privacy or other rules, regulations, laws, procedures or guidelines, liabilities and other losses or damages related in any way to the submission of work to JoVE, making of videos by JoVE, or publication in JoVE or elsewhere by JoVE. The Author shall be responsible for, and shall hold JoVE harmless from, damages caused by lack of sterilization, lack of cleanliness or by contamination due to the making of a video by JoVE its employees, agents or independent contractors. All sterilization, cleanliness or decontamination procedures shall be solely the responsibility of the Author and shall be undertaken at the Author's expense. All indemnifications provided herein shall include JoVE's attorney's fees and costs related to said losses or

damages. Such indemnification and holding harmless shall include such losses or damages incurred by, or in connection with, acts or omissions of JoVE, its employees, agents or independent contractors.

12. **Fees.** To cover the cost incurred for publication, JoVE must receive payment before production and publication the Materials. Payment is due in 21 days of invoice. Should the Materials not be published due to an editorial or production decision, these funds will be returned to the Author. Withdrawal by the Author of any submitted Materials after final peer review approval will result in a US\$1,200 fee to cover pre-production expenses incurred by JoVE. If payment is not received by the completion of filming, production and publication of the Materials will be suspended until payment is received.

13. **Transfer, Governing Law.** This Agreement may be assigned by JoVE and shall inure to the benefits of any of JoVE's successors and assignees. This Agreement shall be governed and construed by the internal laws of the Commonwealth of Massachusetts without giving effect to any conflict of law provision thereunder. This Agreement may be executed in counterparts, each of which shall be deemed an original, but all of which together shall be deemed to me one and the same agreement. A signed copy of this Agreement delivered by facsimile, e-mail or other means of electronic transmission shall be deemed to have the same legal effect as delivery of an original signed copy of this Agreement.

A signed copy of this document must be sent with all new submissions. Only one Agreement required per submission.

AUTHOR:

Name:

Eugene Y Chan

Department:

Institution:

DNA Medicine Institute

Article Title:

Prototype Point-of-Care Blood Diagnostic Assembly with a Flow Cytometry Design for In-Flight Reduced-Gravity Environment Demonstration

Signature:

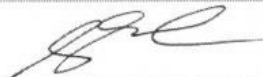

Date:

Monday Oct. 21, 2013

Please submit a signed and dated copy of this license by one of the following three methods:

- 1) Upload a scanned copy as a PDF to the JoVE submission site upon manuscript submission (preferred);
- 2) Fax the document to +1.866.381.2236; or
- 3) Mail the document to JoVE / Attn: JoVE Editorial / 17 Sellers St / Cambridge, MA 02139

For questions, please email editorial@jove.com or call +1.617.945.9051.

MS # (internal use):

Editorial comments/responses:

A) Thank you so much for submitting your revised manuscript and addressing all the editorial changes. All of your previous revisions have been incorporated into the most recent version of the manuscript. Please download this version of the Microsoft word document from the "file inventory" to use for any subsequent changes (File name: 51743_R1_010814).

B) The editor has made the following changes to the manuscript.

1) The editor moved the ethical statement from step 3 to the beginning of the protocol according to the JoVE format and changed the word "section" to "Protocol".

Response: OK

2) In the step 1.1, the editor reverted back the changes to your original manuscript. The editor included "Assemble" before "prototype components..". Additionally, the editor replaced "usable" with "to be used in". The editor ended the parenthesis after micro-gravity to include "conditions" in to the sentence.

Response: OK

3) In step 1.1.3, the editor included "A" in the beginning of the sentence and replaced "that collects" with "to collect" and replaced "that will" with "preventing" and introduced "in" between compromise and flow.

Response/Change(s): Needed rephrasing. Backpressure will compromise flow (which is prevented through our design).

4) In step 1.1.3.2, the editor moved "Loose-fitting or..environment." to the end of the statement and denoted it as a "NOTE" and began the step from "Cap the vials..".

Response: OK

5) In step 1.1.4, the editor included "A" in the beginning of the sentence and replaced "that is usable" with "for use".

Response: OK

6) In step 1.1.4.1, the editor included "such" before "that reliability clamps..". Rephrased the sentence, "preserves.." to "Ensure it preserves..introduction".

Response/Change(s): Missing a subject noun? Added "it."

7) Similarly, in step 1.1.5, the editor included "A" in the beginning of the sentence.

Response: OK

8) In step 1.1.5.2.3, the editor placed "use" before 50 grams elastomer and deleted "should be

appropriate”.

Response: OK

9) In step 1.1.5.2.6, the editor placed a “NOTE” before “Do not overbake PDMS.. drill/cut”.

Response: OK

10) In step 1.1.5.2.8, the editor replaced “A hand magnifier may help aim the needle.” With “Use a hand magnifier to help aim the needle” and rephrased “Holes should be drilled before..” to “Drill holes before..”.

Response/Change(s):

- **Fixed typo “1.1.5.8” -> “1.1.5.2.9”**
- **Otherwise OK**

11) In step 1.1.5.2.10, the editor rephrased “One end should be positioned within the PDMS, approximately 1 mm from the molded surface and the opposite end should stick out the back, non-molded side of the chip.” to “Position one end of the steel pin within the PDMS, 1mm from the molded surface, while the opposite end sticks out on the non-molded back side of the chip.”

Response: OK

12) In step 1.1.6, the editor placed an “A” before “Palm-sized miniature..” Similarly in step 1.1.7.2.

Response: OK

13) In step 1.2, the editor split the step in to a heading, 1.2 and a sub-step 1.2.1. Since the authors have included “[accel]” as Supp. Video 1 in their revision, In step 1.2.1 (previously 1.2), the editor replaced blue stamp “[accel]” with “Supp. Video 1” in parenthesis.

Response: OK

14) In step 1.3.1, the editor placed “A” before mechanism and deleted “may be” and replaced it with “is” and removed the parenthesis. And replaced “onboard” with “on”.

Response: OK

15) In step 1.3.1.1, the editor replaced “Utilized” with “Connect” and removed “to be connected”.

Response: Not sure about this one. The power strip would not be connected to the aircraft power distribution until the rig is loaded onto the plane (which would not occur until the flight day). That’s why it was phrased as “to be connected” (since it is happening later).

16) In step 1.4.2.2, the editor removed the numbers (1), (2), and (3) to comply with JoVE editorial format.

Response: OK

17) In step 1.4.2.4, the editor emphasized “NOTE:” and began the sentence with “The leg straps..” replaced “will be” with “is at”, and replaced “may not be” with “is not”.

Response: Changed to plural (multiple straps for multiple operators).

18) In step 2.2.2, the editor replaced “should be” and began the statement with “Ensure each person..”. and replace “performing” with “performs”, introduced “at” before “each demonstrations” and removed “performance”.

Response: OK

19) In step 2.5.1, the editor removed the numbers (1), (2), and (3) to comply with JoVE editorial format. Placed “the” before “ground..” and “rig”. Corrected “toosl” to “tools”.

Response: OK

20) In step 3, the editor deleted “Here” and began the statement with “Day A is..”.

Response: OK

21) In step 3.3.1, the editor deleted “should be” replaced with “is” and began sentence with “Make sure the..”.

Response: OK

22) In step 3.4.2, the editor removed “(not shown)”. And rephrased the sentence to “Fit vials..”.

Response: Moved word “holder”

23) Since the authors have included “[float up]” as Supp. Video 2 in their revision, In step 3.5.2, the editor replaced blue stamp “[float up]” with “Supp. Video 2” in parenthesis.

Response: OK

C) Please approve the above changes made by the editor or please suggest changes accordingly.

D) Please address the editorial comments below.

1) In the introduction, you mention, “Yu-Chong Tai (Caltech)..”. Please address it as “Yu-Chong Tai and group at Caltech” or “Yu-Chong Tai and coworkers at Caltech” and delete has. Additionally, the editor suggests to remove “and has tested some of his technology in reduced gravity (unpublished).” as these claims cannot be supported by any reference. Unless, it’s critical to the authors to specify it, the authors can end at “..applications[referece]”. Please consider similar for the following statements.

Response/Change(s):

- Yu-Chong Tai appears to have worked with other groups (outside Caltech including several private companies) as well as researchers in his own group. Does the (Caltech) in parentheses need to be eliminated? It simply acts as an identifier.
- Changed text to read “Yu-Chong Tai (Caltech) and colleagues have..” with other word changes.
- Added reference for Dr. Tai’s reduced-gravity testing, which was displayed in a poster presentation:

NASA Human Research Program Investigators’ Workshop (Houston, TX, Feb. 3-5, 2010)

Workshop link: <http://www.dsls.usra.edu/meetings/hrp2010/>

Direct link to abstract: <http://www.dsls.usra.edu/meetings/hrp2010/pdf/ExMC/1018Tai.pdf>

- Does JoVE have a format for poster abstracts?
- Reference numbers adjusted
- Changed text as described for Paul Yager
- For the other “unpublished” experiments, they are specifically mentioned on the cited webpages, but are not apparent in any journals from what we can tell. Removed “unpublished” text.

2) In step 2.3.5 you mention “[video of someone hitting a rig?]” Please indicate which video file this represents to and write it as a blue stamp as this is in the highlighted step. And please highlight it.

Response/Change(s):

- Stamp removed
- If additional footage is needed in the video production, it is a possible candidate.

3) Please try to avoid phrases such as “can be”, “should be”, “might be” etc and write the step in imperative tense, “Do this”, “Make this”, “Mix that”, etc. See example above. Please go through the manuscript steps to minimize such occurrences. For example in step 2.2.4.

Response/Changes(s):

- Change at 1.5.4.2
- Change at 1.7
- Change at 2.2.1
- Change at 2.3.1
- Change at 2.3.3
- Change at 3.3.3
- Some of the examples are hard to change without losing clarity

4) In the “Caution” statement mentioned under 3.1.3, instead of “test methods” did you mean “test samples”?.

Response: The samples are tested before use for various pathogens. The testing methods utilized are highly sensitive and specific but are not 100% sensitive and specific. The phrase “testing methods” is intended.

5) The “NOTE” under step 3.2 mentioned “Nanostrips”. Unless additional details are provided, this statement is likely to be more appropriate following step 3.4.7, to avoid any issue with continuity. Please

consider replacing this statement. If possible please provide a reference as to what the authors are referring to.

Response/Change(s):

- **“Nanostrips” are a proprietary reagent we tested in flight but are not critical to the protocol here.**
- **Altered text in the 4 locations where “nanostrips” were mentioned.**

6) In step 3.6, you mention “high-g” if this is an abbreviation or alternate name for “high-gravitation”, for example, please define the terminology upon its first occurrence.

Response/Change(s):

- **Clarification given in introduction**
- **“high-g” changed to “high-gravitation” in 3.6.**
- **“high-g” left as “high-g” in Discussion**

Reviewer #1:

Manuscript Summary:

This manuscript describes an effort to construct a low gravity flow cytometer. The article focuses on what is seemingly mundane topics such as sample delivery and containment that are routine at normal gravity. Other than some simple pulse data, no actual flow cytometry data is presented. The authors state the instrument is not capable of performing cellular measurements beyond a WBC detection that simply showed random pulses. No description of controls or other details provided. This paper needs to be rewritten with an attempt to provide enough information for evaluation of the work.

Responses:

- With respect to data presentation – the representative data corresponds to the 3 major test objectives of our parabolic flights: (1) Successful blood-saline (and dye mix) in reduced gravity, (2) Ability to detect fluorescent particle samples loaded into the system under reduced gravity, and (3) Demonstration of the cytometer to detect various types of flowing samples (including pre-stained WBCs).
- With respect to controls – controls are identified within the protocol as ground performances of the same demonstrations (see 2.3.1.). There are no comparable ‘gold standards’ for the sample loader or micromixer, although we agree that a quantitative flow cytometer being tested should ideally be compared to a commercial ground cytometer using identical samples to demonstrate fidelity of measurement.

Changes

- Changed title to better reflect the purpose of paper as an example guide to parabolic flight hardware assembly/demonstration (i.e., less about the novelty of a reduced-gravity ready cytometer).
- Added supplementary Figures with additional data traces and analyses in support of the presented method.
- Fixed typos in sentence describing controls in 2.3.1

Major Concerns:

1. There is no discussion of specific performance of target metric What would a successful instrument be able perform, what assays, what cell rates, what sensitivities? Etc...

Response/change(s): Performance metrics of interest added to caption of Fig. 7. This particular system did not have quantified performance targets

2. There are many control experiments that could be performed to compare prototype performance with existing cytometer performance on the ground.

Response: See 1st response above.

3. There is no details provided on where components were purchased or made. The methods of how work was accomplished was provided as a randomly highlighted protocol list.

Response/change(s): Component sources, when included, are described in the Materials List. We have opted not include custom engineering/machining procedures. Highlights in the text indicate procedures selected for filming in conjunction with JoVE editorial staff.

4. The discussion of past and current efforts of relevant point of care flow cytometers (including those

that were designed for low gravity such as the original NPE instrument) was not provided in any detail.

Response: From our understanding, the NPE analyzer was built to meet design specifications that came out of the NASA/American Cancer Society High-Resolution Flow Cytometry Project. However, we are unable to find any evidence that the NPE instrument was ever actually tested in reduced gravity, and therefore we did not consider it initially as an example of a past demonstration that newcomers can look to for parabolic flight guidance. We did list flow cytometers we find 'relevant' in the introduction, based on documented reduced-gravity demonstrations (specifically including those from Crucian, Sams, and Y-C Tai, plus the recent publication on the Microflow1). Current NASA scientists focused on in-flight diagnostics (i.e., co-authors on this paper) reviewed the cited list of past examples before manuscript submission and did not determine that relevant cytometers had been excluded.

Change: Expanded list of 'relevant' cytometers to include those tested in reduced *or designed with reduced gravity in mind*. The NASA/ACS High-Resolution Flow Cytometry Project publications did produce useful guidelines still high relevant today, and thus we agree that the NPE instrument should at least be mentioned.

Minor Concerns:

1. The paper seemed to be very roughly written and just an excerpt from a report.

Additional Comments to Authors

N/A

Reviewer #2:

The manuscript presents a modular method for the construction and operation of a prototype blood diagnostic device in microgravity, based on a flow-based optical system. The design, development and testing is straight forward, systematically described and in-flight experimental procedures were mentioned in detail. Such "point of care" biomedical analytic equipment is without any doubt of highest relevance for future long-term space flights.

The manuscript is very well written, however, some improvements could be recommended:

-The authors described that "countless POC devices have been developed to mimic laboratory scale counterparts, but most have narrow applications and few have demonstrable use in an in-flight, reduced-gravity environment." To substantiate this statement, a short table summarizing the previous development, their field of applications, advantages and disadvantages would be useful.

Response: It's not clear to us whether 'previous development' in the above comment refers to miniaturization efforts in general (i.e., all POC) or POC specifically utilized in the reduced-gravity environment. Note that the quoted sentence is from the Long Abstract and not the main body of the introduction where previous in-flight *in vitro* diagnostics are already described.

Change(s): Changed the text describing the previous cytometers for more clarity. Tabulating the information did not seem to produce favorable results (i.e, took up more space than it saved and didn't contribute significantly to understandability).

- The long list of examples between line 148 and line 167 could be presented also in a short table.

The authors did not describe the flight profile of the "modified privately operated, narrow-body jet airliner", the type of the airlines and the quality of microgravity.

Response/change(s):

-Significantly condensed the information in tabulated form (Table 1).
-Flight profiles for reduced-gravity testing do not vary significantly between flights. Added references for descriptions of typical trajectory and NASA web post regarding the flight week. JoVE discouraged us from including specifics about the plane make/model.

- In the discussion, a short comparison with previous developments (e.g. in fulfilling specific requirements) is missing.

Response/change(s): Added paragraph – new 3rd paragraph in the Discussion.

Reviewer #3:

Manuscript Summary:

No comments

Major Concerns:

No major concerns

Minor Concerns:

- Reference 17 is applied to two different articles. The reference for Laval University's work is missing.

Response: We cannot find any published references for the Laval University technology.

Change(s):

-Deleted second '17' citation.
-Added new ref (webpage) for the Laval U work plus a paper describing the technology outside the context of reduced gravity.

- Line 231: the word 'fluid' is repeated twice.

Change(s):

-Deleted extra 'fluid'.

Additional Comments to Authors:

Excellent manuscript providing clear experimental steps and very useful direct experience that will be appreciated by any investigator testing hardware in parabolic flights.t

Other changes:

-Deleted an unintended '3' in near the end of the Long Abstract
-Several typos fixed throughout
-Thiel et al. (2012) was present twice in the Reference list (eliminated 1 entry.
-Re-evaluated inclusion of some of the References (particularly the previous 1-4, which have been removed)
-Reference list almost entirely reordered, with several other references added.

Highlighted protocol_with blue stamps_012414

[Click here to download Supplemental File \(as requested by JoVE\): Highlighted protocol_with blue stamps_012414.docx](#)

List_to be used for DVD (by author)

[Click here to download Supplemental File \(as requested by JoVE\): List_to be used for DVD.pdf](#)

Supplemental File (as requested by JoVE)

[Click here to download Supplemental File \(as requested by JoVE\): Scriptwriter file_for DVD_updated_030514_SW.docx](#)